



CBL/TN/WJO/3466/ ISSUE C

ILLUSTRATED PARTS CATALOGUE



cameronballoons.co.uk



sales@cameronballoons.co.uk



+44(0)117 9637216

YOUR DETAILS

CUSTOMER NAME:			
DELIVERY ADDRESS:			
EMAIL:			
TELEPHONE:			
VAT REG NUMBER (IF APPLICABLE):			

CUSTOMER DESPATCH INSTRUCTION

UK:	1-2 DAYS	3-5 DAYS	
EUROPE:	1-2 DAYS	3 DAYS	5 DAYS
REST OF WORLD:		3-5 DAYS	

YOUR PAYMENT METHOD

	PAYPAL@CAMERONBALLOONS.CO.UK		
B.A.C.S	CBL ACCOUNT	SUMUP CARD PMT	
EMAIL:			

INTERNAL REFERENCE ONLY

SALES PERSON/ DEALER:			
DATE RECEIVED:		DATE SCHEDULED:	
CUSTOMER ORDER REF:		ORIGINAL	REVISED
DEPOSIT:		CURRENCY:	

aftersales@cameronballoons.co.uk

ORDER FORM

QTY	PART NO.:	DESCRIPTION		PRICE
		YES	NO	
1	FORM1			£8 (€10)

INTRODUCTION

Welcome to the Cameron Balloons Ltd Illustrated Parts Catalogue. Photos and illustrations contained within this manual for reference purposes only.

IMAGES ARE NOT TO SCALE.

Each item within this Catalogue has a dedicated Part Number. This number must be quoted when ordering. Further information such as model, serial number, size, master or standard cylinder and colour may also be required.

If you can not find an item in this Catalogue, please contact aftersales@cameronballoons.co.uk for further assistance.

Cameron Balloons Ltd reserve the right to change, substitute or delete any parts illustrated in this catalogue without prior notice. **Not all parts illustrated are held in stock** and may have to be ordered especially which can lead to delays or long lead times particularly for Lindstrand, T&C and Sky products.

For maintenance and repair instructions for Cameron and Thunder & Colt baskets, burners and fuel systems, please refer to the latest revision of the Cameron Balloons Maintenance Manual. This can be downloaded from www.cameronballoons.co.uk

For burners and fuel cylinders not listed in the Maintenance Manual, please contact Cameron Balloons Ltd for the applicable manuals and advice.

Authorisation to perform maintenance and repair in all cases is given by your National Civil Aviation Authority in accordance with their regulations. Cameron Balloons Ltd accepts no responsibility for either incorrect identification of parts or the fitting of any parts by anyone other than its qualified employees.

Copyright of this manual and illustrations is solely with Cameron Balloons Ltd.

No unauthorised use or reproduction of this manual is permitted without permission in writing from the copyright holder.

	CONTENTS
S1	ENVELOPE COMPONENTS
S2	BURNER & FRAME ACCESSORIES
S3	BASKETS / SAFETY EQUIPMENT
S4	SHADOW / STEALTH / SINGLE / MINI BURNER
S5	STRATUS BURNER
S6	STRATUS NEO BURNER
S7	SIROCCO / SIROCCO 'EP' BURNER
S8	MK 4 SUPER BURNER
S9	COLT MKII / C2 BURNER
S10	C2 PLUS BURNER
S11	COLT MKIII / C3 BURNER
S12	MAGNUM / C3T BURNER
S13	JETSTREAM BURNER
S14	FUEL SYSTEM - REFUELLING
	FUEL SYSTEM - MISCELLANEOUS
	"ALUGAS" FUEL CYLINDERS
	"WORTHINGTON" FUEL CYLINDERS
S15	"DUPLEX" FUEL CYLINDERS
	INFLATION FANS







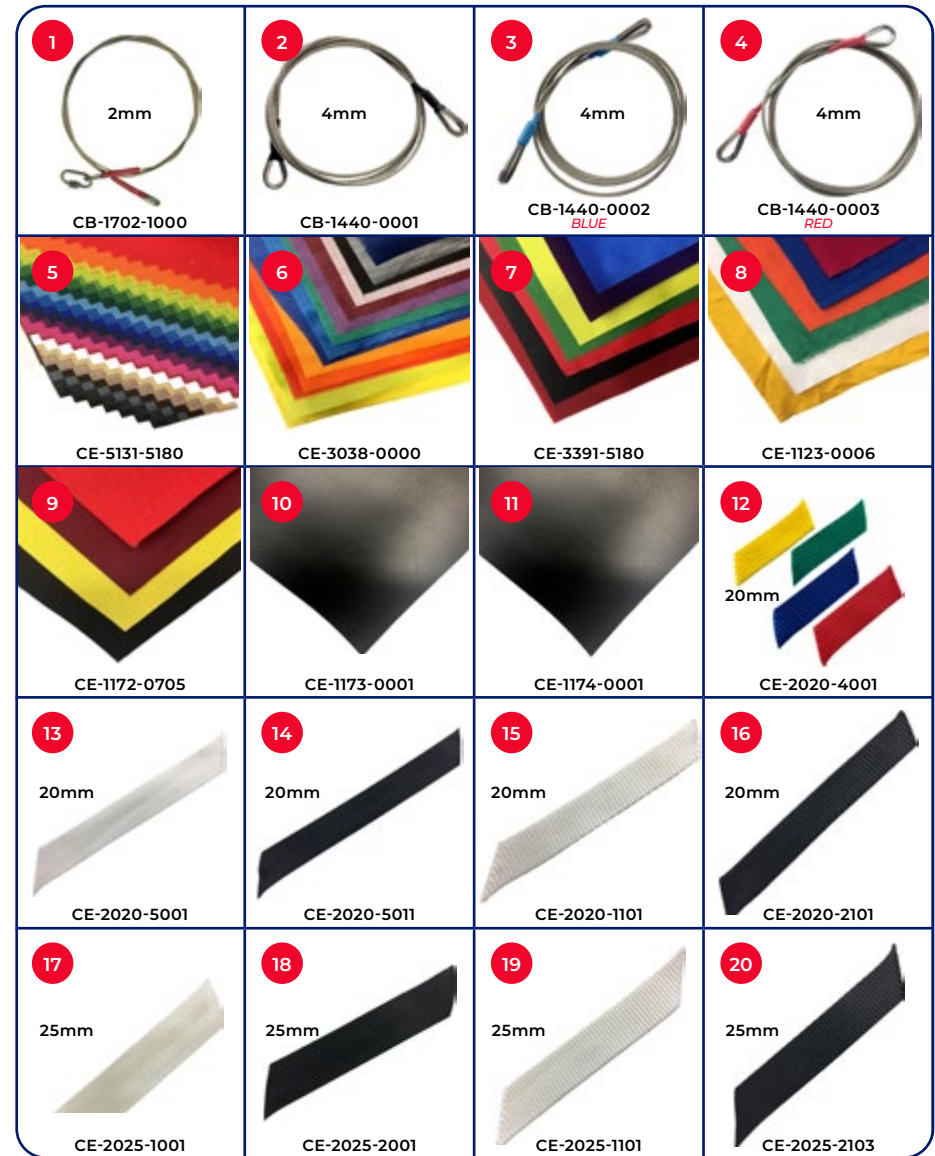



































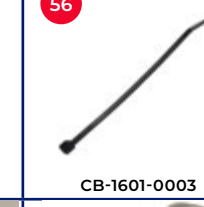

Item	Description	Part #	Item	Description	Part #
1	2MM HOPPER FLYING WIRE WITH MAILLON LINK <i>PLEASE SPECIFY HEATSHRINK COLOUR - BLACK, BLUE OR RED</i>	CB-1702-1000	38	8MM KEVLAR RIPLINE - WHITE	CE-4108-0007
2	4MM FLYING WIRE FOR MAILLON LINK - BLACK	CB-1440-0001	39	8MM CROWNLIN - WHITE	CE-4108-0002
3	4MM FLYING WIRE FOR MAILLON LINK - BLUE	CB-1440-0002	40	10MM CROWNLIN - WHITE	CE-4110-0002
4	4MM FLYING WIRE FOR MAILLON LINK - RED	CB-1440-0003	41	10MM CROWNLIN - BLACK	CE-4110-0001
5	RIPSTOP NYLON - SPECIFY COLOUR	CE-5131-5180	42	LOCKTOP SNAP SHACKLE	CB-0985-2673
6	SUPERLIGHT RIPSTOP NYLON - SPECIFY COLOUR	CE-3038-0000	43	SMALL ENVELOPE PULLEY	CE-4000-0002
7	HYPERLAST - SPECIFY COLOUR	CE-3391-5180	44	ENVELOPE PULLEY WITH BECKET	CE-4000-0003
8	NOMEX - SPECIFY COLOUR	CE-1123-0000	45	RDS PULLEY	CB-1504-0001
9	CORDURA - SPECIFY COLOUR	CE-1172-0700	46	DOUBLE PULLEY BLOCK	CE-4000-0004
10	HEAVYWEIGHT CORDURA - BLACK ONLY	CE-1173-0001	47	10MM XL BECKET PULLEY	CE-4000-0006
11	ENVELOPE BAG PVC BASE FABRIC - BLACK ONLY	CE-1174-0001	48	10MM XL PULLEY	CE-4000-0005
12	20MM TAG TAPE - RED, ROYAL, GREEN OR YELLOW	CE-2020-4001	49	STAINLESS STEEL TURNING VENT PULLEY	CE-4000-0007
13	20MM FLAT POLYESTER WEBBING TAPE - WHITE	CE-2020-5001	50	TURNING VENT LINE BULLET / CAPSULE	CB-1505-0000
14	20MM FLAT POLYESTER WEBBING TAPE - BLACK	CE-2020-5011	51	HEATSHRINK CAPS FOR KEVLAR PARACHUTE LINE - GREY	CE-4103-0002
15	20MM POLYESTER WEBBING TAPE - WHITE	CE-2020-1101	52	4MM X 40MM HEATSHRINK - RED OR BLACK	CB-0367-0005
16	20MM POLYESTER WEBBING TAPE - BLACK	CE-2020-2101	53	5MM MAILLON LINK	CE-4103-0005
17	25MM FLAT TAPE - WHITE	CE-2025-1001	54	5MM TWISTED SHACKLE	CB-1601-0002
18	25MM FLAT TAPE - BLACK	CE-2025-2001	55	6MM TWISTED SHACKLE	CB-1601-0001
19	25MM POLYESTER TUBULAR WEBBING - WHITE	CE-2025-1101	56	CABLE TIE FOR TWISTED SHACKLE	CB-1601-0003
20	25MM POLYESTER TUBULAR WEBBING - BLACK	CE-2025-2103	57	TEMPERATURE FLAG, LINK & 2 X 3MM MAILLONS	CE-4260-1001
21	25MM HEAVYWEIGHT LOAD TAPE - WHITE	CE-2025-3001	58	TEMPERATURE LINK ONLY	CE-4260-1002
22	45MM POLYESTER WEBBING - WHITE	CE-2045-1001	59	TEMPERATURE LINK & 2 X 3MM MAILLONS	CE-4260-1005
23	45MM POLYESTER WEBBING - BLACK	CE-2045-1002	60	TEMPERATURE FLAG	CE-4260-1003
24	20MM VELCRO - HOOK & LOOP - SPECIFY COLOUR	CE-3020-0001	61	3MM MAILLON LINK FOR USE WITH TEMPERATURE LINK	CE-4260-1004
25	25MM VELCRO SUPERHOOK - SPECIFY WHITE OR BLACK	CE-3025-1000	62	TEMPILABEL	CE-4000-0001
26	50MM VELCRO - HOOK & LOOP - SPECIFY WHITE OR BLACK	CE-3050-0002	63	THREAD - 3,500M PER REEL	CE-4300-1001
27	3MM KEVLAR PARACHUTE LINE - YELLOW	CE-4103-0001	64	BARBOBS TYPE G - COMPLETE BOX = 50 BOBBINS CONTAINING 34M EACH	CE-4300-0002
28	3MM POLYESTER PARACHUTE LINE - WHITE	CB-1504-0003	65	NOMEX THREAD - NB: PRE-WOUND BARBOBS NOT AVAILABLE	CE-4300-0003
29	3.5MM TURNING VENT LINE - GREEN	CE-4135-0002	66	SCOOP SPRING HOOK	CE-4300-0007
30	3.5MM TURNING VENT LINE - BLACK	CE-4135-0001	67	SCOOP SHACKLE - SMALL - CONNECTS SCOOP TO ENVELOPE	CE-4300-0008
31	6MM KEVLAR LINE - BLACK	CE-4106-0001	68	SCOOP SHACKLE - LARGE - CONNECTS SCOOP TO FRAME	CE-4300-0027
32	6MM KEVLAR LINE - GREEN	CE-4106-0002	69	D RING - ALUMINIUM	CE-4300-0009
33	6MM POLYESTER BRAID ON BRAID - WHITE	CE-4106-0004	70	D RING - STAINLESS STEEL	CE-4300-0026
34	6MM KEVLAR RIPLINE - RED/WHITE	CE-4106-0003	71	1" (25MM) RING - STAINLESS STEEL	CK-3000-0004
35	8MM KEVLAR RIPLINE - RED	CE-4108-0001	72	SCOOP SPRINGS	CE-4300-0032
36	8MM KEVLAR RIPLINE - RED/WHITE	CE-4108-0005	73	4MM PEAR-SHAPED MAILLON	CB-1504-0005
37	8MM KEVLAR RIPLINE - BLACK/YELLOW	CE-4108-0006	74	RDS SILICON O-RING	CB-1504-0006
			75	40MM STAINLESS STEEL RING	CB-1504-0004

Item	Description	Part #
76	ENVELOPE RIPLOCK HOOK	CE-4300-0010
77	ENVELOPE LABEL	CE-4300-0011
78	ENVELOPE BAG LABEL - WOVEN - SPECIFY BALLOON TYPE & SIZE	CE-4300-0031
79	CROWNLINER KARABINER - TOP (CONNECTS TO LOOPED TAPE ON CROWN RING)	CE-4300-0024
80	CROWNLINER KARABINER - BOTTOM (NEAREST TO BASKET)	CE-4300-0025
81	ENVELOPE NUMBER LABELS	CE-4300-0040
82	STICKY-BACKED RIPSTOP NYLON FABRIC - WHITE	CE-7160-0011
83	STICKY-BACKED RIPSTOP NYLON FABRIC - BLACK	CE-7160-0012
84	STICKY-BACKED RIPSTOP NYLON FABRIC - PLEASE SPECIFY COLOUR	CE-7125-5198
85	STICKY-BACKED RIPSTOP NYLON FABRIC - GOLD OR SILVER	CE-7126-9996
86	REGISTRATION LETTERS - ONE SET	CE-8000-0000
87	ENVELOPE PROTECTOR WITH NUMBER <i>AVAILABLE IN WHITE OR BLACK LOAD TAPE, WITH RED, BLACK OR BLUE TAB - PLEASE SPECIFY NUMBER</i>	CB-0734-0001
88	ENVELOPE REPAIR TAPE - SUPPLIED IN 5M LENGTHS - SPECIFY COLOUR	CE-1000-0000
89	AMBERGLIDE PTFE LUBRICANT	CE-9000-0001
90	ENVELOPE BAG SNAP HOOK	CG-1000-1020
91	SCOOP SNAP HOOK	CG-1000-1022
92	GRAB TEST CLAMPS	CE-0000-0009
93	GRAB TEST SPRING BALANCE	CE-0000-0003
94	SEESAFE WINDOW TAPE	CA-0001-1087
95	SEESAFE WINDOW FABRIC	CA-0000-4055
96	2.5T KARABINER	CU-9820-0003
97	4T KARABINER	CU-9825-0001
98	5T KARABINER	DISCONTINUED
99	HOPPER ENVELOPE KARABINER	CU-9821-0001
100	KARABINER TIDY - 4 PER PACKET	CU-9500-0004
101	LARGE HEATSHRINK - CROWNLINER - BLACK	CB-0367-0009
102	3MM HEATSHRINK - RDS - BLACK	CB-1504-0008
103	BONANNO QUICK RELEASE	CB-9000-0005
104	V BRIDLE WITH RINGS	CB-6043-3000
105	50M TETHER LINE	CE-4114-0002
106	PARACHUTE VELCRO SET REPLACEMENT - CONTACT CBL FOR DETAIL	CB-1427-1000



ENVELOPE COMPONENTS & ACCESSORIES



ENVELOPE COMPONENTS & ACCESSORIES

<p>21</p>  <p>25mm</p> <p>CE-2025-3001 <i>WHITE ONLY</i></p>	<p>22</p>  <p>45mm</p> <p>CB-2045-1001 <i>WHITE ONLY</i></p>	<p>23</p>  <p>45mm</p> <p>CE-2045-1002 <i>BLACK ONLY</i></p>	<p>24</p>  <p>20mm</p> <p>CE-3020-0001 <i>A VARIETY OF COLOURS AVAILABLE</i></p>	<p>25</p>  <p>25mm SUPERHOOK</p> <p>CE-3025-1000 <i>AVAILABLE IN BLACK OR WHITE</i></p>	<p>26</p>  <p>50mm SUPERHOOK</p> <p>CE-3050-0002 <i>AVAILABLE IN BLACK OR WHITE</i></p>	<p>27</p>  <p>3mm</p> <p>CE-4103-0001</p>	<p>28</p>  <p>3mm</p> <p>CB-1504-0003</p>	<p>29</p>  <p>3.5mm</p> <p>Upper Turning Vent Line</p> <p>CE-4135-0002</p>
<p>30</p>  <p>3.5mm</p> <p>Upper Turning Vent Line</p> <p>CE-4135-0001</p>	<p>31</p>  <p>6mm</p> <p>Lower Turning Vent Line</p> <p>CE-4106-0001</p>	<p>32</p>  <p>6mm</p> <p>Lower Turning Vent Line</p> <p>CE-4106-0002</p>	<p>33</p>  <p>6mm</p> <p>Bag Rope</p> <p>CE-4106-0004</p>	<p>34</p>  <p>6mm</p> <p>Ripline</p> <p>CE-4106-0003</p>	<p>35</p>  <p>8mm</p> <p>Ripline</p> <p>CE-4108-0001</p>	<p>36</p>  <p>CE-4108-0005</p>	<p>37</p>  <p>8mm</p> <p>CE-4108-0006</p>	<p>38</p>  <p>8mm</p> <p>CE-4108-0007</p>
<p>39</p>  <p>8mm</p> <p>Crownline</p> <p>CE-4108-0002</p>	<p>40</p>  <p>10mm</p> <p>Crownline</p> <p>CE-4110-0002</p>	<p>41</p>  <p>10mm</p> <p>CE-4110-0001</p>	<p>42</p>  <p>CB-0985-2673</p>	<p>43</p>  <p>CE-4000-0002</p>	<p>44</p>  <p>CE-4000-0003</p>	<p>45</p>  <p>CB-1504-0001</p>	<p>46</p>  <p>CE-4000-0004</p>	<p>47</p>  <p>10mm</p> <p>CE-4000-0006</p>
<p>48</p>  <p>10mm</p> <p>CE-4000-0005</p>	<p>49</p>  <p>CE-4000-0007</p>	<p>50</p>  <p>CB-1505-0000</p>	<p>51</p>  <p>CE-4103-0002</p>	<p>52</p>  <p>CB-0367-0005 <i>BLACK OR RED</i></p>	<p>53</p>  <p>5mm</p> <p>CE-4103-0005</p>	<p>54</p>  <p>5mm</p> <p>CB-1601-0002</p>	<p>55</p>  <p>6mm</p> <p>CB-1601-0001</p>	<p>56</p>  <p>CB-1601-0003</p>
<p>57</p>  <p>CE-4260-1001</p>	<p>58</p>  <p>CE-4260-1002</p>	<p>59</p>  <p>CE-4260-1005</p>	<p>60</p>  <p>CE-4260-1003</p>	<p>61</p>  <p>3mm</p> <p>CE-4260-1004</p>	<p>62</p>  <p>CE-4000-0001</p>	<p>63</p>  <p>CE-4300-1001</p>	<p>64</p>  <p>CE-4300-0002</p>	<p>65</p>  <p>CE-4300-0003</p>

ENVELOPE COMPONENTS & ACCESSORIES

<p>66</p>  <p>CE-4300-0007</p>	<p>67</p>  <p>CE-4300-0008</p>	<p>68</p>  <p>CE-4300-0027</p>	<p>69</p>  <p>CE-4300-0009</p>	<p>70</p>  <p>CE-4300-0026</p>	<p>71</p>  <p>25mm CK-3000-0004</p>	<p>72</p>  <p>CE-4300-0032</p>	<p>73</p>  <p>4mm CB-1504-0005</p>	<p>74</p>  <p>CB-1504-0006</p>
<p>75</p>  <p>40mm CB-1504-0004</p>	<p>76</p>  <p>CE-4300-0010</p>	<p>77</p>  <p>CE-4300-0011 <i>PLEASE SPECIFY TYPE & SIZE</i></p>	<p>78</p>  <p>CE-4300-0031</p>	<p>79</p>  <p>CE-4300-0024</p>	<p>80</p>  <p>CE-4300-0025</p>	<p>81</p>  <p>CE-4300-0040</p>	<p>82</p>  <p>CE-7160-0011</p>	<p>83</p>  <p>CE-7160-0012</p>
<p>84</p>  <p>CE-7125-5198</p>	<p>85</p>  <p>CE-7126-9996</p>	<p>86</p>  <p>CE-8000-0000 <i>ONE SET</i></p>	<p>87</p>  <p>CB-0734-0001 <i>ALSO AVAILABLE IN BLACK TAPE</i></p>	<p>88</p>  <p>CE-1000-0000 <i>SUPPLIED IN 5M LENGTHS</i></p>	<p>89</p>  <p>CE-9000-0001 <i>AIR FREIGHT RESTRICTIONS APPLY</i></p>	<p>90</p>  <p>For Envelope Bag CG-1000-1020</p>	<p>91</p>  <p>For Scoop CG-1000-1022</p>	<p>92</p>  <p>CE-0000-0009</p>
<p>93</p>  <p>CE-0000-0003</p>	<p>94</p>  <p>CA-0001-1087</p>	<p>95</p>  <p>CA-0000-4055</p>	<p>96</p>  <p>2.5t CU-9820-0003</p>	<p>97</p>  <p>4t CU-9825-0001</p>	<p>98</p>  <p>5t DISCONTINUED</p>	<p>99</p>  <p>Hopper CU-9821-0001</p>	<p>100</p>  <p>CU-9500-0004</p>	<p>101</p>  <p>CB-0367-0009</p>
<p>102</p>  <p>3mm CB-1504-0008</p>	<p>103</p>  <p>CG-9000-0005</p>	<p>104</p>  <p>CB-6043-3000</p>	<p>105</p>  <p>CE-4114-0002</p>	<p>106</p>  <p>CB-1427-0000 <i>CONTACT CBL FOR DETAIL</i></p>				

Item	Description	Part #
1	CAMERON GIMBAL BLOCK ASSEMBLY DOUBLE	CB-2950-2000
2	CAMERON GIMBAL BLOCK ASSEMBLY TRIPLE/QUAD	CB-2950-1000
3	M8 AEROTIGHT NUT, STAINLESS STEEL	CY-0008-1004
4	M8 PLAIN WASHER, STAINLESS STEEL	CY-0008-2008
5	GIMBAL BLOCK WEAR PAD	CB-8626-0000
6	GIMBAL BLOCK STUD, DOWEL PIN M10 X 26	CB-8570-0000
7	GIMBAL BLOCK SPRING DISC WASHER - USE ON CURRENT & OLD STYLE	CB-8603-0000
8	M6 X 16 CAP HEAD BOLT HEX SOCKET - FOR OLD STYLE CB2556 GIMBAL	CY-0005-3016
9	M5 SPRING WASHER - FOR OLD STYLE CB2556 GIMBAL	CY-0005-2007
10	FRAME - POLE SOCKETS - FLEXI CORNER	CB-0211-0000
11	FLEXICORNER NYLON BUSHES	CB-0212-2000
12	FLEXICORNER FASTENER KIT	CU-1006-4050
13	FRAME - BOLT/NUT/WASHER	CU-1008-0065
14	SADDLE -	CB-0543-0004
	<i>Ø19MM TUBE (PLEASE SPECIFY THICKNESS - 4.76, 6.35, 11.11 OR 15.9MM)</i>	
	<i>Ø25MM TUBE (PLEASE SPECIFY THICKNESS - 4.76, 6.35 OR 11.11MM)</i>	
15	BRASS SPACERS -	CB-0735-0001
	<i>Ø19MM TUBE (PLEASE SPECIFY THICKNESS- 1.5MM, 3MM, 5MM, 6.5MM OR 8MM)</i>	
	<i>Ø25MM TUBE (PLEASE SPECIFY THICKNESS - 1.5MM, 3MM, 5MM, 6.5MM OR 8MM)</i>	
16	ADJUSTABLE FRAME KNOB	DISCONTINUED
17	SADDLE - OUTER	CB-2068-2000
18	SADDLE - INNER	CB-2068-1000
19	GAS STRUT - SINGLE	CB-2224-0003
20	GAS STRUT - DOUBLE	CB-2204-0003
21	HEATSHIELD SCREW	CB-3142-0001
22	HEATSHIELD WASHER	CB-3142-0002
23	ADJUSTABLE FRAME BOLT	CB-2891-0000
24	ADJUSTABLE FRAME LEVER	CB-2204-0004
25	STRUT PIVOT PIN	CB-8886-0000
26	FRICTION DISC	CB-0551-0002
	<i>Ø19MM OR Ø25MM (PLEASE SPECIFY THICKNESS)</i>	
27	LOCTITE SCREW LOCK 222 - 10ML	CU-0000-0001
28	LOCTITE NUT LOCK 243 - 10ML	CU-0000-0003
29	LOCTITE 270 - 10ML	CU-0000-0002
30	LEAK DETECTING SOLUTION - DELIVERY RESTRICTIONS MAY APPLY	CU-0000-0004
31	SILIGLIDE AEROSOL - DELIVERY RESTRICTIONS MAY APPLY	CU-0000-0005
32	LOCTITE 572 - 50ML	CU-0000-0006
33	CAMERON KSP125 - 10 GRAM SYRINGE	CU-0000-0010
34	CAMERON KSP125 - 50 GRAM SYRINGE	CU-0000-0050
35	PTFE TAPE	CU-0000-0007

Item	Description	Part #
36	PTFE PASTE - TRUE BLUE	CU-0000-0008
37	8MM CIRCLIP	CU-2204-0011
38	LONG SEAL BULLET TOOL - FOR INSTALLATION OF 'O RINGS' ONTO STEM	CB-2348-6000
39	SHORT SEAL BULLET TOOL - FOR INSTALLATION OF 'O RINGS' ONTO STEM	CB-2348-7000
40	SADDLE	CB-8854-0000
41	BURNER FRAME - CONTACT CBL FOR MORE DETAIL	CB-88##-####

GIMBAL BLOCK ASSEMBLY

Current Style - CB-2950-1000

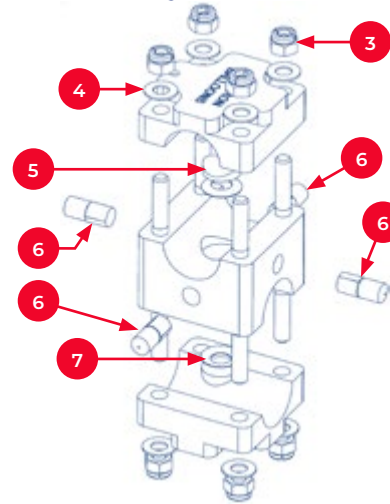

CB-2950-2000 ILLUSTRATED

Current Style

4x **6** Triple / Quad

2x **6** Double

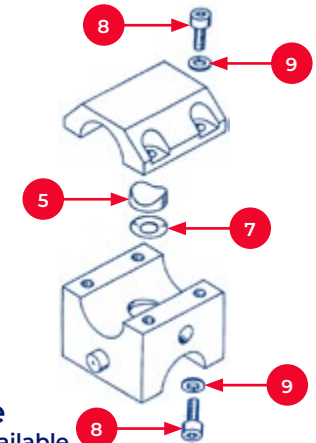

Old Style

No longer available
Main Body & Caps Replaced



























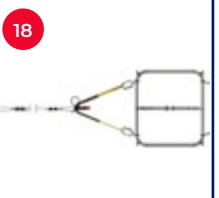

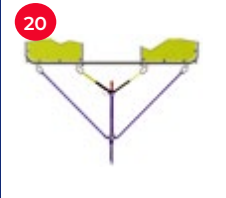













GIMBAL BLOCK ASSEMBLY AND FRAME ACCESSORIES

 <p>1 CB-2950-2000 <i>DOUBLE</i></p>	 <p>2 CB-2950-1000 <i>TRIPLE/QUAD</i></p>	 <p>3 CY-0008-1004</p>	 <p>4 CY-0008-2008</p>	 <p>5 CB-8626-0000</p>	 <p>6 CB-8570-0000</p>	 <p>7 CB-8603-0000</p>	 <p>8 CY-0005-3016</p>	 <p>9 CY-0005-2007</p>
		 <p>10 CB-0211-0000</p>	 <p>11 CB-0212-2000</p>	 <p>12 CU-1006-4050</p>	 <p>13 CU-1008-0065</p>	 <p>14 CB-0543-0004 <i>PLEASE SPECIFY TUBE Ø</i></p>	 <p>15 CB-0735-0001 <i>PLEASE SPECIFY TUBE Ø</i></p>	 <p>16 DISCONTINUED</p>
 <p>17 CB-2068-2000 <i>OUTER</i></p>	 <p>18 CB-2068-1000 <i>INNER</i></p>	 <p>19 CB-2224-0003</p>	 <p>20 CB-2204-0003</p>	 <p>21 CB-3142-0001</p>	 <p>22 CB-3142-0002</p>	 <p>23 CB-2891-0000</p>	 <p>24 CB-2204-0004</p>	 <p>25 CB-8886-0000</p>
 <p>26 CB-0551-0002</p>	 <p>27 CU-0000-0001</p>	 <p>28 CU-0000-0003</p>	 <p>29 CU-0000-0002</p>	 <p>30 CU-0000-0004</p>	 <p>31 CU-0000-0005</p>	 <p>32 CU-0000-0006</p>	 <p>33 CU-0000-0010</p>	 <p>34 CU-0000-0050</p>
 <p>35 CU-0000-0007</p>	 <p>36 CU-0000-0008</p>	 <p>37 CU-2204-0011</p>	 <p>38 CB-2438-6000 <i>PLEASE SPECIFY BURNER & APPLICATION</i></p>	 <p>39 CB-2438-7000 <i>PLEASE SPECIFY BURNER & APPLICATION</i></p>	 <p>40 CB-8854-0000 <i>INNER</i></p>	 <p>41 CB-88##-#### <i>CONTACT CBL FOR MORE DETAIL</i></p>		

Item	Description	Part #
LEATHER/ SUEDE TOP		
1	PREPARED LEATHER PER METER <i>CHOICE OF COLOUR, LEATHER OR SUEDE</i>	CG-2000-1000
2	LEATHER PER SQ.FT <i>FULL OR HALF-HIDE, CHOICE OF COLOURS</i>	CG-2000-1001
3	RETRIM - P.O.A <i>CHOICE OF COLOUR, LEATHER OR SUEDE</i>	ASK FOR DETAILS
PADDING		
4	ARMAFLEX 19042 PER/M	CG-1000-0004
5	ARMAFLEX 09028 PER/M	CG-1000-0005
6	ARMAFLEX 25048 PER/M	CG-1000-0022
7	BLACK BASKET BRAID	CG-2100-0001
8	RED BASKET BRAID	CG-2100-0002
9	3MM WHITEPOLY PARACHUTE LINE	CB-1504-0003
LEATHER/HIDE BOTTOM		
10	BASKET BASE LEATHER PER PIECE	CG-0000-0001
11	LIMED HIDE	CG-1000-0001
COMPARTMENT		
12	CROSSBRACING PILOT COMPARTMENT	CB-3417-0000
TOWING STROP		
13	BASKET TOWING STROP	CB-3346-0000
POLE COVERS		
14	NYLON POLES VARIOUS SIZES <i>CUSTOMER SUPPLIED MEASUREMENTS</i>	CB-0532-####
15	LEATHER POLE COVERS <i>CHOICE OF COLOUR</i>	CG-1000-3000
16	T&C POLE COVER <i>CHOICE OF COLOUR</i>	CA-0001-1047
17	POLE AND COVER BAG <i>CHOICE OF COLOUR</i>	CG-4000-0000
QUICK RELEASES		
18	TYPE 1 STANDARD QUICK RELEASE	CB-3574-1000
19	TYPE 2 QUICK RELEASE ASSEMBLY	CB-3575-1000
20	TYPE 3 QUICK RELEASE ASSEMBLY	CB-3576-1000
21	TYPE 4 HEAVY DUTY QUICK RELEASE ASSEMBLY	CB-3577-1000
22	50M TETHER LINE	CE-4114-0002
PILOT & PASSENGER RESTRAINT HARNESSSES		
23	PILOT RESTRAINT HARNESS WITH BAG <i>CHOICE OF BAG COLOUR</i>	CB-0929-5000
24	PILOT RESTRAINT STRAP FLOOR	CB-0929-5001
25	PILOT HARNESS WAIST BELT	CB-0929-5002

Item	Description	Part #
26	PILOT RESTRAINT BAG ONLY	CB-0929-5003
27	PILOT RESTRAINT HARNESS ONLY	CB-0929-5004
28	WOVEN FLOOR RESTRAINT	CB-3248-0000
29	SOLID FLOOR RESTRAINT	CB-8248-0000
30	PASSENGER HARNESS	CB-3515-0000
31	PASSENGER HARNESS + ANCHOR	CB-3515-2000
32	BLACK CYLINDER STRAP	CB-3487-1000
33	NAVY CYLINDER STRAP	CB-3487-2000
SAFETY EQUIPMENT		
34	FIRE EXTINGUISHER	CG-6000-0000
35	FIRE EXTINGUISHER BAG	CG-6000-0003
36	FIRE EXTINGUISHER POCKET	CG-6000-0005
37	FIRST AID KIT FOR BOX	CG-6000-1002
38	FIRST AID KIT BAG	CG-6000-1003
39	FIRST AID KIT COMPLETE	CG-6000-1004
40	SAFETY KIT COMPLETE	CB-3621-0000
41	SAFETY KIT BAG	CB-3621-1000
ANCILLARIES		
42	*50M DROPLINE IN CASE WITH KARABINER <i>CHOICE OF CASE COLOUR</i>	CG-8000-0000
43	DROPLINE CASE ONLY	CG-8000-1000

BASKET COMPONENTS & ANCILLARIES

 <p>1 CG-2000-1000 CHOICE OF COLOUR, LEATHER OR SUEDE</p>	 <p>2 CG-2000-1001 FULL OR HALF-HIDE, CHOICE OF COLOURS</p>	 <p>3 ASK FACTORY FOR DETAIL CHOICE OF COLOUR, LEATHER OR SUEDE</p>	 <p>4 CG-1000-0004</p>	 <p>5 CG-1000-0005</p>	 <p>6 CG-1000-0022</p>	 <p>7 CG-2100-0004</p>	 <p>8 CG-2100-0002</p>	 <p>9 3mm CG-1504-0003</p>
 <p>10 CG-0000-0001</p>	 <p>11 CG-1000-0001</p>	 <p>12 CB-3417-0000</p>	 <p>13 CB-3346-0000</p>	 <p>14 CB-0532-#### CUSTOMER SUPPLIED MEASUREMENTS</p>	 <p>15 CG-1000-3000 CHOICE OF COLOUR</p>	 <p>16 CA-0001-1047 CHOICE OF COLOUR</p>	 <p>17 CG-4000-0000 CHOICE OF COLOUR</p>	 <p>18 CB-3574-10000</p>
 <p>19 CB-3575-1000</p>	 <p>20 CB-3576-1000</p>	 <p>21 CB-3577-1000</p>	 <p>22 CE-4114-0002</p>	 <p>23 CB-0929-5000 CHOICE OF BAG COLOUR</p>	 <p>24 CB-0929-5001</p>	 <p>25 CB-0929-5002</p>	 <p>26 CB-0929-5003</p>	 <p>27 CB-0929-5004</p>
 <p>28 CB-3280-0000</p>	 <p>29 CB-8248-0000</p>	 <p>30 CB-3515-0000</p>	 <p>31 CB-3515-2000</p>	 <p>32 CB-3487-1000</p>	 <p>33 CB-3487-2000</p>	 <p>34 CG-6000-0000 PLEASE SPECIFY</p>	 <p>35 CG-6000-0003</p>	 <p>36 CG-6000-0005</p>
 <p>37 CG-6000-1002</p>	 <p>38 CG-6000-1003</p>	 <p>39 CG-6000-1004</p>	 <p>40 CB-3621-0000</p>	 <p>41 CB-3621-1000</p>	 <p>42 CG-8000-0000 CHOICE OF CASE COLOUR</p>	 <p>43 CG-8000-1000</p>		

Item	Description	Part #
1	AMAL MAIN JET	CB-0214-0003
2	COPPER WASHER	CB-0214-0006
3	3/8 BSP SEALING RING	CB-0392-0021
4	3/8 BSP SEAL	CB-0392-0022
8	MULTI HOLE MAIN JET	CB-0923-0001
10	SHADOW / STEALTH BURNER MANIFOLD RIGHTHAND	CB-2006-1000
11	SHADOW / STEALTH BURNER MANIFOLD LEFTHAND	CB-2006-2000
12	SHADOW / STEALTH BURNER INNER FOIL	CB-2009-0020
13	SHADOW / STEALTH BURNER OUTER FOIL	CB-2009-0021
15	PIEZOELECTRIC IGNITION ASSEMBLY	CB-2011-0000
17	BLAST VALVE HANDLE ASSEMBLY - INC. HANDLE, CAM & SCREW (RED)	CQ-2022-0000
18	WHISPER VALVE HANDLE ONLY (BLUE)	CB-2015-2000
19	PILOT VALVE HANDLE ONLY (GOLD)	CB-2015-3000
20	SLEEVE	CB-2015-4000
22	UPPER CAM (INCLUDES INNER WASHER RIGHTHAND)	CB-2016-1000
23	UPPER CAM (INCLUDES INNER WASHER LEFTHAND)	CB-2016-2000
24	LOWER CAM RIGHTHAND	CB-2016-3000
25	LOWER CAM LEFTHAND	CB-2016-4000
26	WHISPER VALVE LOWER BODY	CB-2017-0000
29	WHISPER VALVE STEM	CB-2020-0000
30	PILOT LIGHT CAM RIGHTHAND	CB-2021-1000/3000
31	PILOT LIGHT CAM LEFTHAND	CB-2021-2000/4000
32	PILOT LIGHT VALVE STEM	CB-2022-0000
36	COVER STRIP & SCREW	CB-2026-0002
38	BLAST VALVE STEM ASSEMBLY	CB-2029-0000
42	BLANKING PLUG (INCLUDES SEAL - SEE ITEM 92)	CB-2033-1000
43	HANDLE END CAP	CB-2034-0000
46	STEALTH JET RING NUT & STUD	CB-2040-0000
47	VAPOUR ADAPTOR	CB-2047-0001
48	FRICTION WASHER	CB-2048-1001

Item	Description	Part #
49	VAPOUR SPACER TUBE	CB-2069-0001
50	WHISPER HANDLE EXTENSION LEFTHAND	CB-2134-0001
51	WHISPER HANDLE EXTENSION RIGHTHAND	CB-2134-0002
52	LEAK DUCT TUBE	CU-4872-0000
55	SHADOW / STEALTH COIL	CB-2193-1000
56	SHADOW COIL NO JETS - PLEASE SPECIFY RH OR LH	CB-2209-2000
57	SHADOW CAN RIGHTHAND	CB-2209-2100
58	SHADOW CAN LEFTHAND	CB-2209-2100
59	DOUBLE BURNER HANDLE	CB-2210-0000
62	DOUBLE BURNER BRACKET	CB-2212-0000
63	M6 HEX HEAD BOLT GIMBAL	CB-2213-0000
64	TRIPLE BURNER BRACKET	CB-2216-0000
65	STEALTH CAN RIGHTHAND/GIMBAL	CB-2238-2001
66	STEALTH CAN LEFTHAND/GIMBAL	CB-2238-2002
67	TRIPLE BURNER HANDLE	CB-2249-0000
68	QUAD BURNER BRACKET	CB-2252-0000
69	QUAD BURNER HANDLE	CB-2253-0000
70	DOUBLE BURNER CROSSFLOW (COMPLETE)	CB-2290-0000
72	3/4" BSP SEALING RING	CB-2290-2001
73	3/4" BSP SEAL	CB-2290-2002
78	VAPOUR FILTER SPRING	CU-4873-5000
80	LIQUID REGULATOR HEATER	CB-2434-0000
81	REGULATOR (COMPLETE ASSEMBLY - MOD C298)	CB-2429-0000
84	PRESSURE GAUGE TAKE-OFF FITTINGS	CB-2472-0000
86	BLAST VALVE SPRING	CU-7553-0009
87	PILOT LIGHT FLAME TUBE ASSY RIGHTHAND	CB-2530-1000
88	PILOT LIGHT FLAME TUBE ASSY LEFTHAND	CB-2530-2000
89	BLAST VALVE SERVICE KIT	CB-2601-0000
90	WHISPER VALVE SERVICE KIT	CB-2602-0000
91	LIQUID PILOT LIGHT JET KIT	CB-2603-0000

Item	Description	Part #
92	LIQUID PILOT LIGHT REGULATOR SERVICE KIT	CB-2604-0000
93	LIQUID PILOT LIGHT VALVE STEM SERVICE KIT	CB-2605-0000
94	VAPOUR PILOT LIGHT SERVICE KIT	CB-2606-0000
95	BLAST VALVE MAIN SEAL KIT	CB-2607-0000
96	WHISPER/CROSSFLOW REPAIR KIT	CB-2612-0000
98	STEALTH/SHADOW PRESSURE GAUGE	CU-2948-5000
99	PRESSURE GAUGE GASKET	CU-2948-5001
100	MAIN VALVE LUBE SCREW	CU-4871-8000
101	PILOT VALVE SPRING	CU-4872-4000
105	M5 X 16 RAISED CSK HEAD (SLOTTED)	CY-0005-5016
106	M5 X 6 GRUB SCREW HEX SOCKET	CY-0005-6006
107	M6 AEROTIGHT NUT	CY-0006-1004
108	M6 X 10 CAP HEAD BOLT HEX SOCKET	CY-0006-3010
109	M6 X 16 CAP HEAD BOLT HEX SOCKET	CY-0006-3016
113	2 X M6 X 6 GRUB SCREW HEX SOCKET - FLAT	CU-4872-8000
114	2 X M6 X 6 GRUB SCREW HEX SOCKET - POINTED	CU-4873-2000
<p><i>USE EITHER FLAT OR POINTED M6 GRUB SCREW DEPENDANT ON IGNITER TYPE. INCORRECT SCREW WILL RESULT IN EXCESSIVE MOVEMENT OF IGNITER.</i></p>		
119	PRESSURE GAUGE (SINGLE BURNER)	CB-2130-0001
120	SINGLE HANDLE END CAP (RED)	CB-2139-0001
121	SINGLE MANIFOLD GASKET	CB-2135-0018
122	SINGLE HANDLE END CAP (GREEN)	CB-2139-0002
123	BURNER TOOL KIT - SPANNER	CB-2438-1000
131	LUBE SCREW 'O' RINGS - 5 PACK	CB-2609-0000
132	SLURPER - CURVED (SINGLE)	CB-2138-2000
133	SLURPER - STRAIGHT DOUBLE/TRIPLE/QUAD	CB-2138-1000
<p><i>CROSSFLOW - ** ALL ITEMS BELOW FOR SQUEEZE ACTION HANDLE ONLY (FOR NON-SQUEEZE ACTION DOUBLE BURNERS - SEE ITEM 70)</i></p>		
124	CROSSFLOW TUBE - STRAIGHT (TRIPLE/QUAD)	CB-2334-0000
125	CROSSFLOW TUBE - CURVED (TRIPLE/QUAD)	CB-2336-0000
126	CROSSFLOW VALVE	CB-8598-0000
127	BANJO BOLT	CB-2335-0000
128	COPPER WASHER	CB-2344-0004
129	TRIPLE CROSSFLOW ASSEMBLY (COMPLETE)	CB-2324-0000

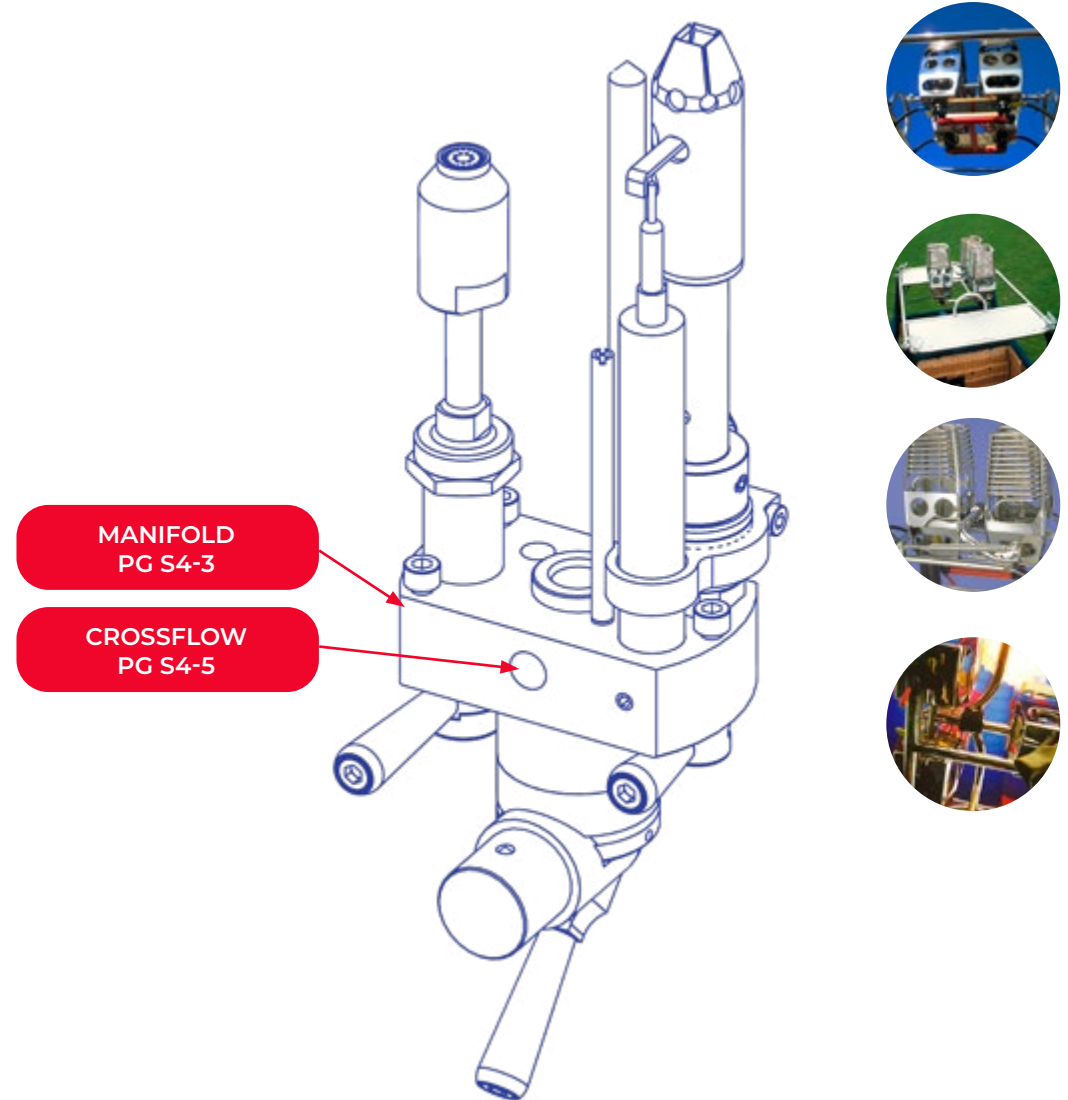



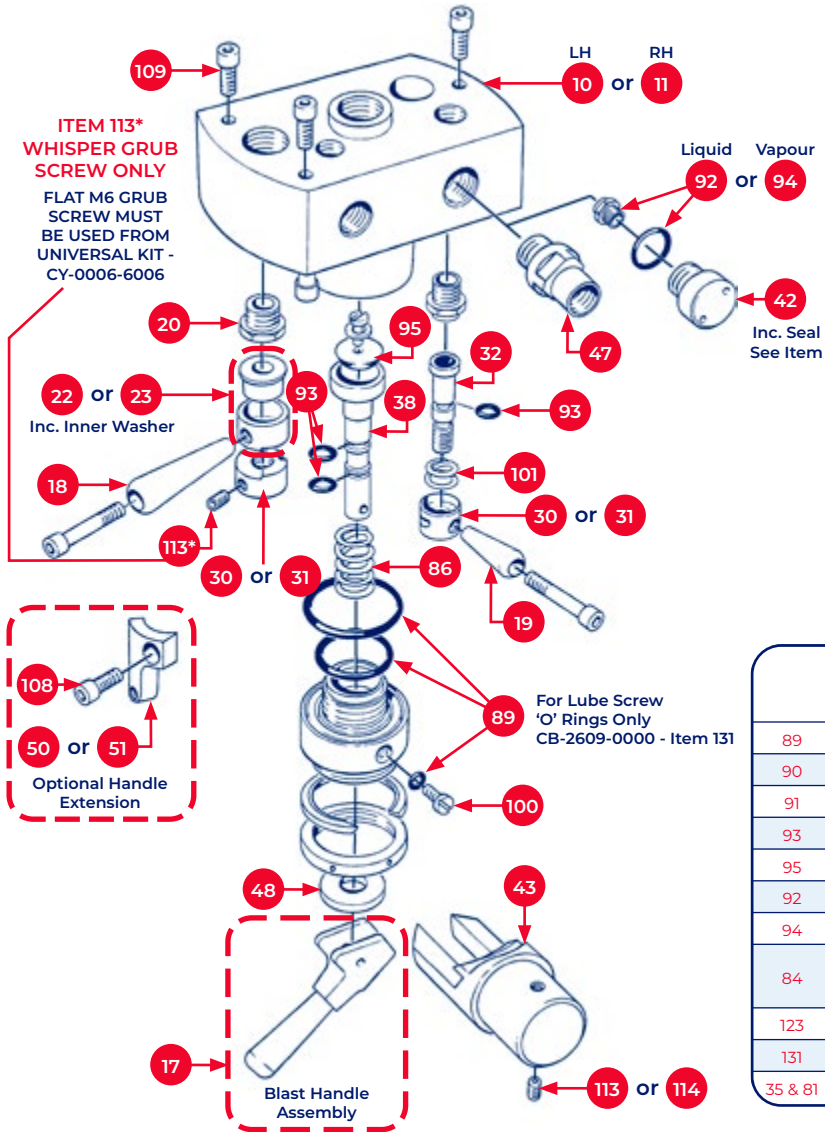



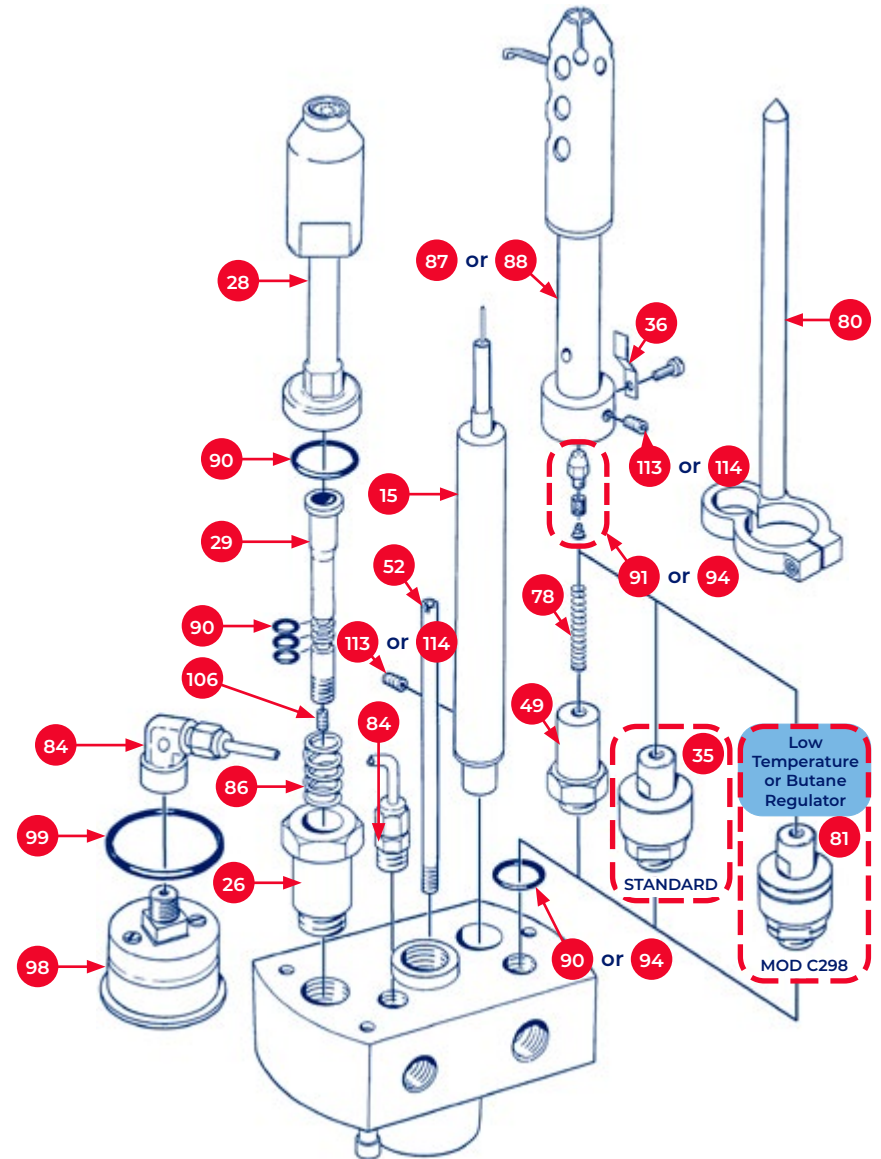











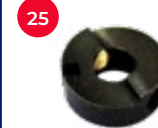













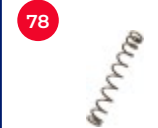
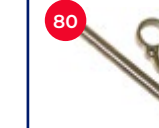





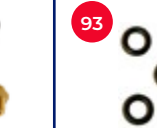

DOUBLE/TRIPLE/QUAD VALVE & MANIFOLD FITTINGS

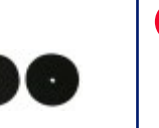

NOTES	
SEAL KIT ITEMS	
89	CB-2601-0000
90	CB-2602-0000
91	CB-2603-0000 (Liquid)
93	CB-2605-0000
95	CB-2607-0000
92	Part of CB-2604-0000
94	CB-2606-0000 (Vapour)
84	CB-2472-0000 (Stainless Steel Kit) DO NOT MIX WITH BRASS
123	Burner Tool Kit - Red Spanner
131	Lube Screw 'O' Rings - CB-2609-0000
35 & 81	Internal 'O' Rings within item 92

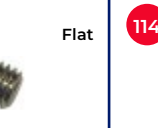

DOUBLE/TRIPLE/QUAD VALVE & MANIFOLD FITTINGS

 <p>10 CB-2006-200 LEFTHAND</p>	 <p>11 CB-2006-1000 RIGHTHAND</p>	 <p>15 CB-2011-0000</p>		 <p>17 CQ-2022-0000 RED</p>	 <p>18 CB-2015-2000 BLUE</p>	 <p>19 CB-2015-3000 GOLD</p>	 <p>20 CB-2015-4000</p>	 <p>22 CB-2016-1000 RH (INC. INNER WASHER)</p>
 <p>23 CB-2016-2000 LEFTHAND (INC. INNER WASHER)</p>	 <p>24 CB-2016-3000 RIGHTHAND</p>	 <p>25 CB-2016-4000 LEFTHAND</p>	 <p>26 CB-2017-0000</p>	 <p>28 CB-2018-2019</p>	 <p>29 CB-2020-0000</p>	 <p>30 CB-2021-1000 RIGHTHAND</p>	 <p>31 CB-2021-2000 LEFTHAND</p>	 <p>32 CB-2022-0000</p>
 <p>35 CB-2026-0000 (STANDARD) FOR MOD C298, SEE ITEM 81</p>	 <p>36 CB-2026-0002</p>	 <p>38 CB-2029-0000</p>	 <p>42 CB-2033-1000</p>	 <p>43 CB-2034-0000</p>	 <p>47 CB-2047-0001</p>	 <p>48 CB-2048-1001</p>	 <p>49 CB-2069-0001</p>	 <p>50 CB-2134-0001 LEFTHAND</p>
 <p>51 CB-2134-0002</p>	 <p>52 CU-4872-0000</p>	 <p>78 CU-4873-5000</p>	 <p>80 CB-2434-0000</p>	 <p>81 CB-2429-0000 (MOD C298) FOR STANDARD, SEE ITEM 35</p>	 <p>84 CB-2472-0000 DO NOT MIX WITH BRASS</p>	 <p>86 CU-7553-0009</p>	 <p>87 CB-2530-1000 RIGHTHAND</p>	 <p>88 CB-2530-2000 LEFTHAND</p>
 <p>89 CB-2601-0000</p>	 <p>90 CB-2602-0000</p>	 <p>91 CB-2603-0000</p>	 <p>92 CB-2604-0000 LIQUID PILOT LIGHT REGULATOR KIT</p>	 <p>93 CB-2605-0000 LIQUID PILOT VALVE STEM KIT</p>	 <p>94 CB-2606-0000 VAPOUR PILOT LIGHT SERVICE KIT</p>	 <p>95 CB-2607-0000 BLAST VALVE KIT</p>	 <p>98 CU-2948-5000</p>	 <p>99 CU-2948-5001</p>
 <p>100 CU-4871-8000</p>	 <p>101 CU-4872-4000</p>	 <p>106 CY-0005-6006</p>	 <p>108 CY-0006-3010</p>	 <p>109 CY-0006-3016</p>	 <p>113 Flat CU-4872-8000</p>	 <p>114 Pointed CU-4873-2000</p>	 <p>123 CB-2438-1000</p>	 <p>131 CB-2609-0000 LUBE SCREW 'O' RINGS</p>

CAN, MOUNTING, CROSSFLOW, HANDLES, CANS, COILS, JETS & FOILS

DOUBLE CROSSFLOW

TRIPLE CROSSFLOW

STANDARD CROSSFLOW

FOR NON- SQUEEZE BAR ACTION BURNER

Double or Quad - Complete

70	CB-2290-0000
----	--------------

SEAL KIT ITEMS

96	CB-2612-0000
----	--------------

CROSSFLOW ASSEMBLIES

FOR SQUEEZE BAR ACTION BURNER

Triple or Quad - Straight Complete Assembly
(For Quad, One or Two sets can be ordered)

One set Contains:

126	1x CB-8598-0000
124	2x CB-2334-0000
127	2x CB-2335-0000
128	4x CB-2344-0004





































TRIPLE SQUEEZE ASSY - CURVED COMPLETE

Contains:

124	1x CB-2334-0000
125	1x CB-2336-0000
126	1x CB-8598-0000
127	2x CB-2335-0000
128	4x CB-2344-0004

FOR GIMBAL BLOCK OPTIONS - SEE SECTION S2 - BURNER & FRAME ACCESSORIES

ENVELOPE COMPONENTS & ACCESSORIES

 <p>1 CB-0214-0003</p>	 <p>2 CB-0214-0006</p>	 <p>3 CB-0392-0021</p>	 <p>4 CB-0392-0022</p>	 <p>8 CB-0923-0001</p>	 <p>9 CB-2005-0020</p>	 <p>12 CB-2009-0020 <i>INNER</i></p>	 <p>13 CB-2009-0021 <i>OUTER</i></p>	 <p>46 CB-2040-0000</p>
 <p>55 CB-2193-1000 <i>SPECIFY LEFTHANDED OR RIGHTHANDED</i></p>	 <p>56 CB-2209-2000 <i>(NO JETS) SPECIFY LEFTHANDED OR RIGHTHANDED</i></p>	 <p>57 CB-2209-2100 <i>RIGHTHAND</i></p>	 <p>58 CB-2209-2100 <i>LEFTHAND</i></p>	 <p>59 CB-2210-0000</p>	 <p>62 CB-2212-0000</p>	 <p>63 CB-2213-0000</p>	 <p>64 CB-2216-0000</p>	
 <p>65 CB-2238-2001 <i>RIGHTHANDED/GIMBAL</i></p>	 <p>66 CB-2238-2002 <i>LEFTHANDED/GIMBAL</i></p>	 <p>67 CB-2249-0000</p>	 <p>68 CB-2252-0000</p>	 <p>69 CB-2253-0000</p>	 <p>70 CB-2290-0000 <i>DOUBLE</i></p>	 <p>72 CB-2290-2001</p>	 <p>73 CB-2290-2002</p>	
 <p>96 CB-2612-0000</p>	 <p>105 CY-0005-5016</p>	 <p>107 CY-0006-1004</p>	 <p>124 CB-2334-0000 <i>SQUEEZE ACTION ONLY</i></p>	 <p>125 CB-2336-0000 <i>TRIPLE BURNER - CURVED SQUEEZE ACTION ONLY</i></p>	 <p>126 CB-8598-0000 <i>SQUEEZE ACTION ONLY</i></p>	 <p>127 CB-2335-0000 <i>SQUEEZE ACTION ONLY</i></p>	 <p>128 CB-2344-0004 <i>SQUEEZE ACTION ONLY</i></p>	 <p>129 CB-2324-0000 <i>TRIPLE</i></p>
 <p>132 CB-2138-2000 <i>SINGLE - CURVED</i></p>	 <p>133 CB-2138-1000 <i>DOUBLE/TRIPLE/QUAD - STRAIGHT</i></p>							

MANIFOLD & VALVE FITTINGS, HANDLE AND COIL ASSEMBLY

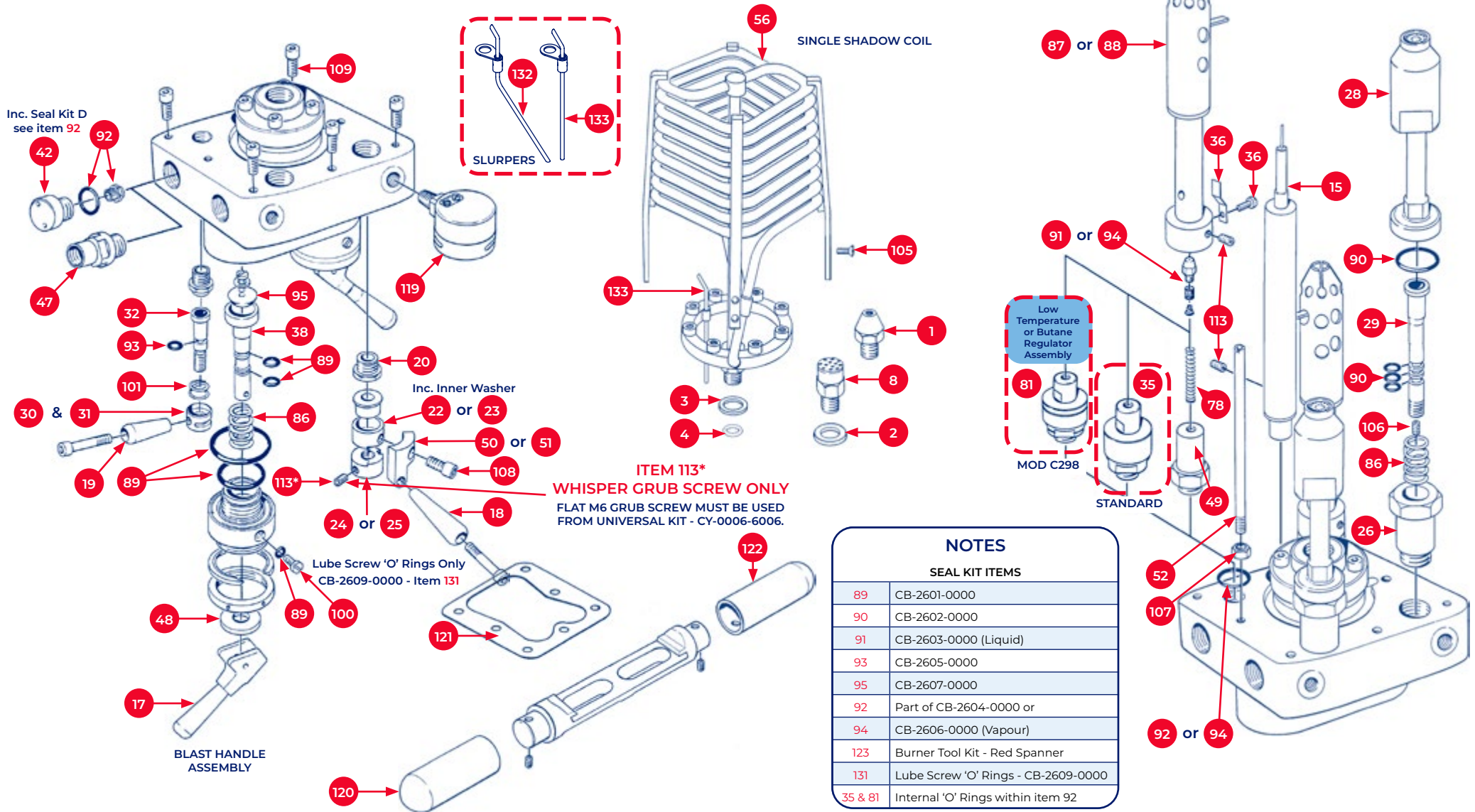

MANIFOLD & VALVE FITTINGS, HANDLE AND COIL ASSEMBLY

 1 CB-0214-0003	 2 CB-0214-0006	 3 CB-0392-0021	 4 CB-0392-0022	 8 CB-0923-0001	 15 CB-2011-0000	 17 CQ-2022-0000 <i>RED</i>	 18 CB-2015-2000 <i>BLUE</i>	 19 CB-2015-3000 <i>GOLD</i>	
 20 CB-2015-4000	 22 CB-2016-1000 <i>RH INC. INNER WASHER</i>	 23 CB-2016-2000 <i>INC. INNER WASHER</i>	 24 CB-2016-3000 <i>RIGHTHAND</i>	 25 CB-2016-4000 <i>LEFTHAND</i>	 26 CB-2017-0000	 28 CB-2018-2019	 29 CB-2020-0000	 30 CB-2021-3000 <i>RIGHTHAND</i>	 31 CB-2021-4000 <i>LEFTHAND</i>
 32 CB-2022-0000	 35 CB-2026-0000 <i>(STANDARD) FOR MOD C298, SEE ITEM 81</i>	 36 CB-2026-0002	 38 CB-2029-0000	 42 CB-2033-0000	 47 CB-2047-0001	 48 CB-2048-0001	 49 CB-2069-0001	 50 CB-2134-0001 <i>LEFTHAND</i>	 51 CB-2134-0002 <i>RIGHTHAND</i>
 52 CB-2140-0000	 56 CB-2209-2000 <i>NO JETS</i>	 78 CU-4873-5000	 81 CB-2429-0000 <i>(MOD C298) FOR STANDARD, SEE ITEM 35</i>	 86 CU-7553-0009	 87 CB-2530-1000 <i>RIGHTHAND</i>	 88 CB-2530-2000 <i>LEFTHAND</i>	 89 CB-2601-0000 <i>BLAST VALVE KIT</i>	 90 CB-2602-0000 <i>WHISPER KIT</i>	 91 CB-2603-0000 <i>LIQUID PILOT LIGHT KIT</i>
 92 CB-2604-0000 <i>LIQUID PILOT LIGHT REGULATOR KIT</i>	 93 CB-2605-0000 <i>LIQUID PILOT VALVE STEM KIT</i>	 94 CB-2606-0000 <i>VAPOUR PILOT LIGHT SERVICE KIT</i>	 95 CB-2607-0000 <i>BLAST VALVE KIT</i>	 100 CU-4871-8000	 101 CU-4872-4000	 105 CY-0005-5016	 106 CY-0005-6006	 107 CY-0006-1004	 108 CY-0006-3010
 109 CY-0006-3016	 113 Flat CU-4872-8000	 114 Pointed CU-4873-2000	 119 CB-2130-0001	 120 CB-2139-0001 <i>RED</i>	 121 CB-2135-0018	 122 CB-2139-0002 <i>GREEN</i>	 123 CB-2438-1000	 131 CB-2609-0000 <i>LUBE SCREW O'RINGS</i>	 133 CB-2138-1000 <i>DOUBLE/TRIPLE/QUAD- STRAIGHT</i>

Item	Description	Part #	Item	Description	Part #
1	3/8 BSP SEALING RING - OUTER	CB-0392-0021	55	PILOT VALVE DOWEL	CB-8515-0000
2	3/8 BSP SEALING RING - INNER	CB-0392-0022	56	PILOT VALVE SPRING	CB-8516-0000
3	BLAST VALVE BONNET	CB-8523-0000	58	VAPORISER SPRING	CB-8539-0000
4	BLAST VALVE WEAR PAD	CB-8524-0000	59	VAPORISER INLET FITTING	CB-8545-0000
5	BLAST TRIGGER PIN	CB-8527-0000	60	SINTERED BRONZE FILTER	CB-8546-0000
6	HANDLE BOSS	CB-8528-0000	61	LIQUID PILOT LIGHT JET	CB-8550-0000
7	HANDLE END FITTING	CB-8529-0000	62	VAPORISER OUTLET FITTING (LIQUID REGULATOR)	CB-8556-0000
8	SLURPER TUBE	CB-8531-0000	63	IGNITER CERAMIC - INSULATED SLEEVE	CB-8557-0000
9	MAIN BLAST JET	CB-8548-0000	64	IGNITER ELECTRODE - INCLUDES NUT	CB-8561-0000
10	BLAST TRIGGER ASSEMBLY	CB-8566-0000	65	PILOT LIGHT AIR REGULATOR	CB-8565-0000
15	COIL ASSEMBLY	CB-8600-1000	68	VAPOUR PILOT VALVE SPRING	CB-8607-0000
16	BLAST TRIGGER SPRING	CB-8602-0000	69	PILOT VALVE SEAL KIT	CB-8614-1000
17	STRATUS MAIN VALVE SEAL KIT	CB-8612-1000	70	VAPORISER SEAL KIT	CB-8624-1000
19	3/8 BSP BONDED SEAL	CH-3800-0003	71	M3 X 16 CAP HEAD BOLT	CY-0003-3016
21	BLAST VALVE SPRING	CU-7553-0009	72	GAUGE FEED COPPER WASHER	CB-8540-0000
22	M5 X 14 CAP HEAD BOLT	CY-0005-3014	73	GAUGE FEED PIPE ASSEMBLY LEFTHAND	CB-8551-4000
23	M5 X 25 CAP HEAD BOLT	CY-0005-3025	75	GAUGE FEED PIPE ASSEMBLY RIGHTHAND	CB-8551-5000
24	M5 AEROTIGHT NUT	CY-0005-1004	77	PRESSURE GAUGE	CB-8590-0000
25	M5 X 16 BUTTON HEAD BOLT	CY-0005-4016	78	CAN - DOUBLE, TRIPLE OR QUAD	CB-8503-0000
26	M5 WASHER	CY-0005-2009	79	DOUBLE HANGER	CB-8504-0000
27	M8 WASHER	CY-0008-2008	80	DOUBLE HANDLE	CB-8530-0000
28	LIQUID FIRE VALVE WEAR PAD	CA-0000-8227	81	BLOCK O-RING - DOUBLE, TRIPLE OR QUAD	CB-8533-0000
29	TOGGLE / PIVOT PIN	CA-0000-8299	93	QUAD HANDLE	CB-8647-2000
30	TOGGLE / PIVOT PIN CIRCLIP (5MM)	CA-0000-8300	94	TRIPLE HANGER	CB-8592-0000
31	TOGGLE VALVE STEM (MAIN VALVE)	CB-8520-0000	95	TRIPLE HANDLE	CB-8593-0000
<i>FOR LIQUID VALVE ONLY ON SINGLE STRATUS BURNER, PLEASE NOTE DIMENSIONAL CHANGE CONTACT AFTERSALES@CAMERONBALLOONS.CO.UK FOR FURTHER INFORMATION</i>			96	QUAD HANGER	CB-8596-0000
32	LIQUID FIRE VALVE BONNET	CB-8521-0000	99	M3 X 12 CSK HEAD BOLT	CY-0003-5012
33	LIQUID FIRE TOGGLE	CB-8522-0000	100	CROSSFLOW PORT PLUG	CB-8532-0000
34	LIQUID FIRE NOZZLE ASSEMBLY	CB-8553-0000	101	TRIPLE CROSSFLOW TUBE - STRAIGHT	CB-8594-0000
35	HIGH OUTPUT LIQUID FIRE NOZZLE ASSEMBLY	CB-8554-0000	102	TRIPLE CROSSFLOW TUBE - CURVED	CB-8595-0000
39	3/8 BSP COPPER GASKET	CA-0000-8201	103	QUAD CROSSFLOW TUBE	CB-8646-0000
46	PIEZO IGNITER	CB-8505-0000	104	STRATUS CROSSFLOW VALVE ONLY	CB-8598-0000
47	IGNITER HOUSING	CB-8506-0000	105	BANJO BOLT	CB-8599-0000
48	IGNITER O-RING SEAL KIT - 5 PACK	CB-8506-1000	113	SOCKET TOOL (PILOT LIGHT)	CB-8650-1004
49	STRATUS IGNITER SPRING (REPLACES IGNITER LEAD)	CB-8664-0000	114	IGNITER TOOL	CB-8650-1002
50	FLAME TUBE ASSEMBLY	CB-8639-0000	117	STRATUS MANIFOLD BLOCK LEFTHAND	CB-8501-0000
51	PILOT VALVE STEM	CB-8511-0000	118	STRATUS MANIFOLD BLOCK RIGHTHAND	CB-8502-0000
52	PILOT VALVE NUT	CB-8512-0000	119	MAIN VALVE STEM	CB-4169-0000
53	PILOT VALVE KNOB	CB-8513-0000	<i>FOR LIQUID VALVE ONLY ON SINGLE STRATUS BURNER, PLEASE NOTE DIMENSIONAL CHANGE CONTACT AFTERSALES@CAMERONBALLOONS.CO.UK FOR FURTHER INFORMATION</i>		
54	PILOT VALVE LEVER	CB-8514-0000			

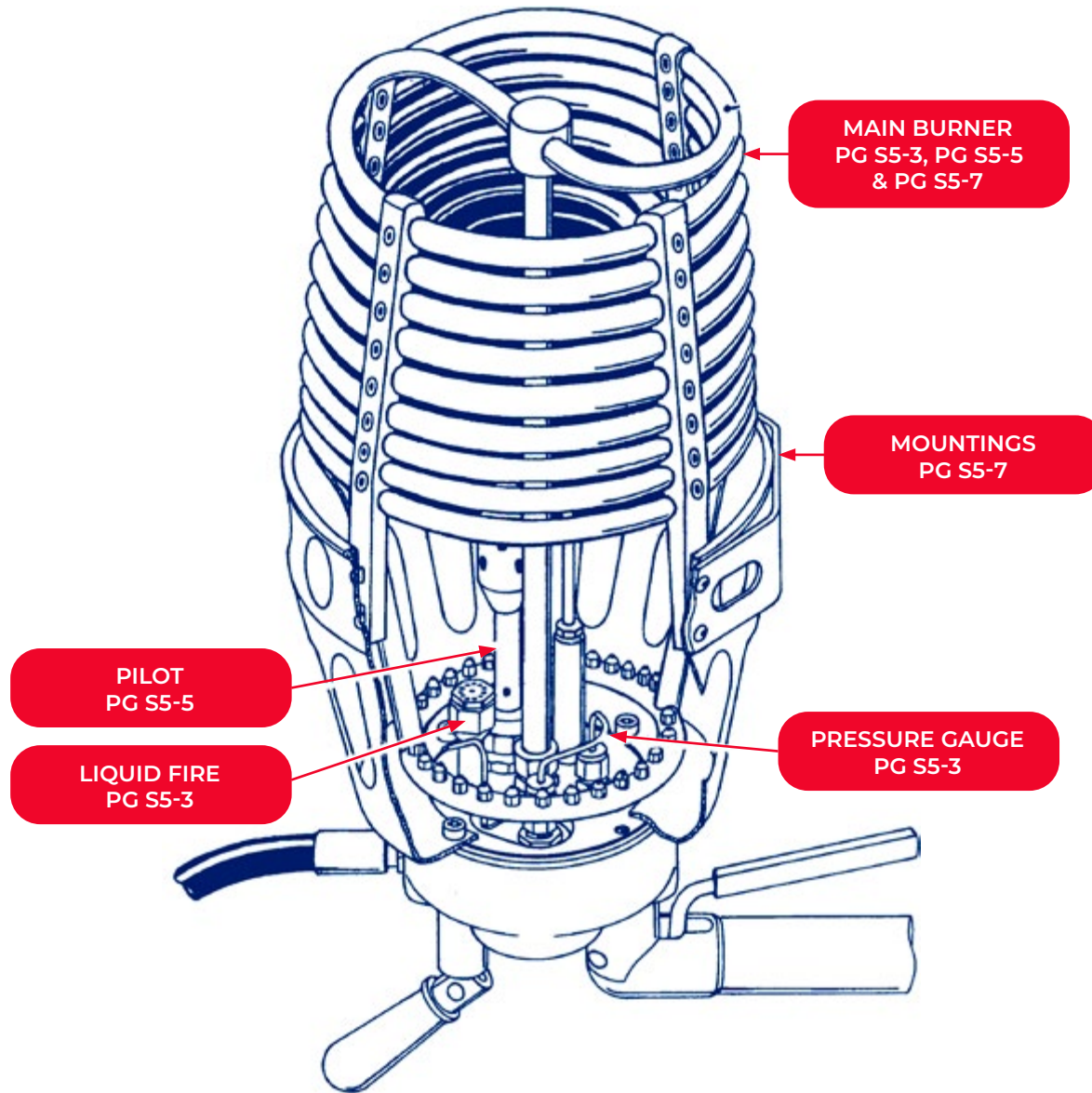

MAIN BLAST VALVE, CROSSFLOW, LIQUID FIRE & PRESSURE GAUGE ASSEMBLY

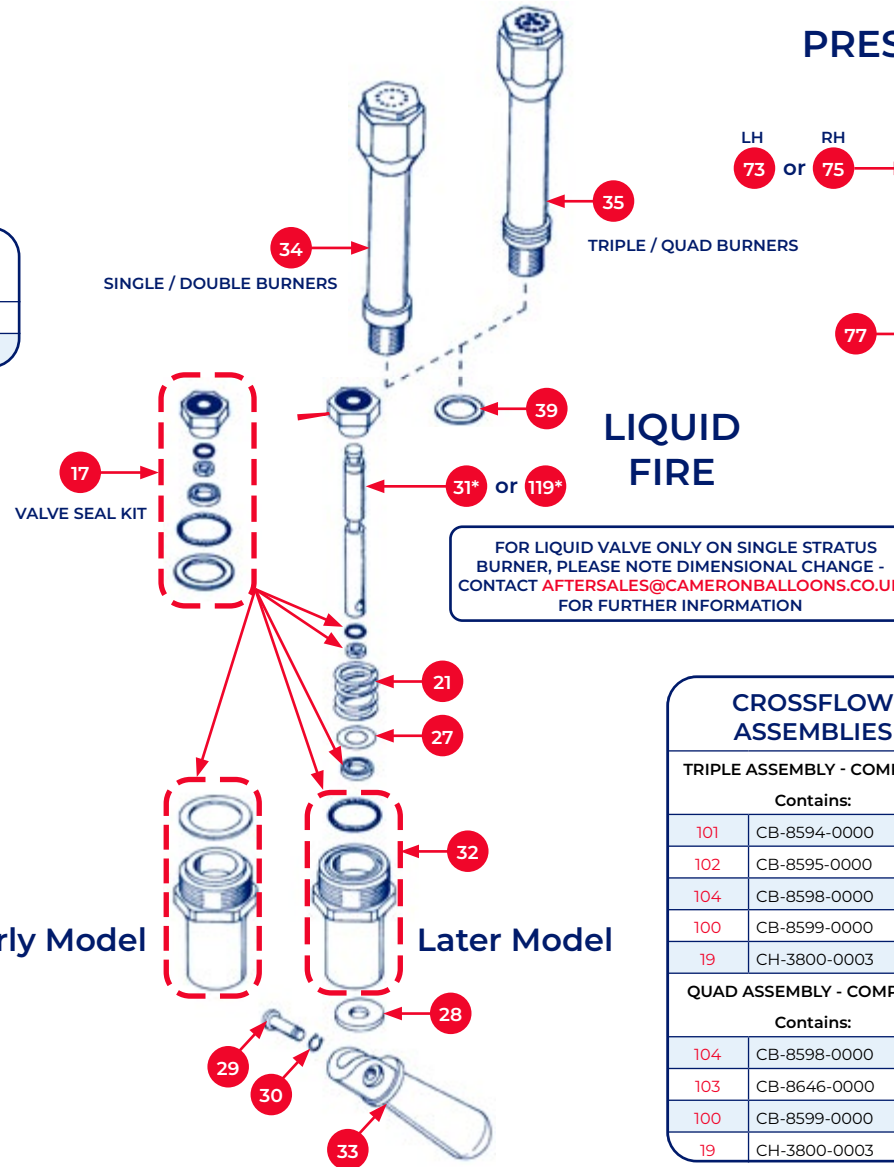
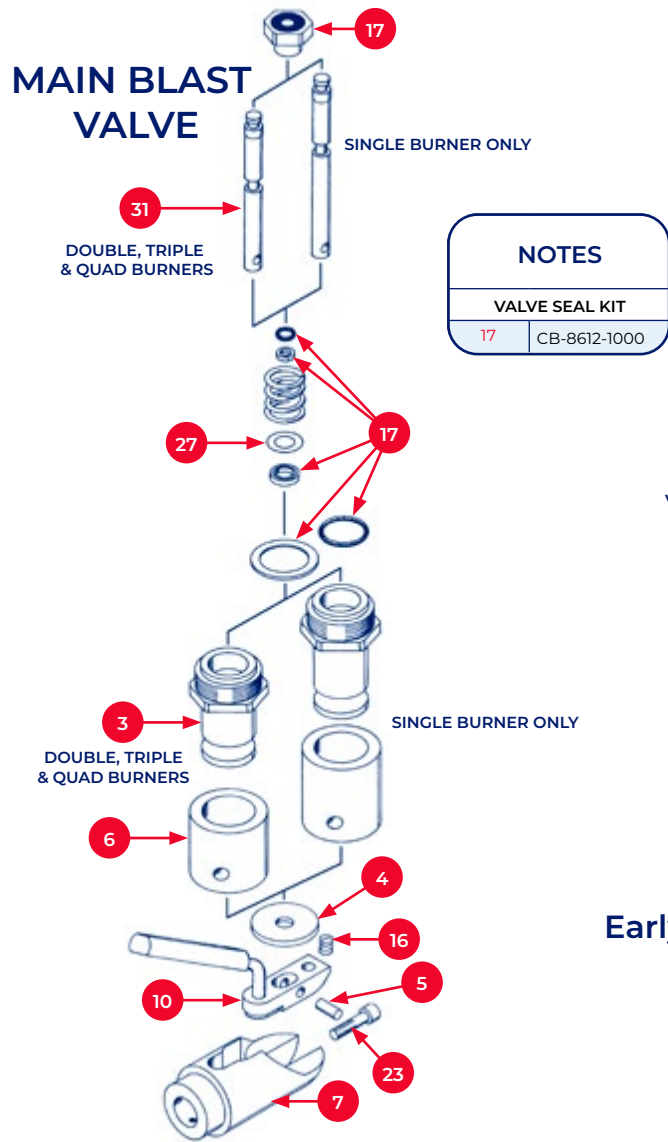

PRESSURE PIPE ASSEMBLY

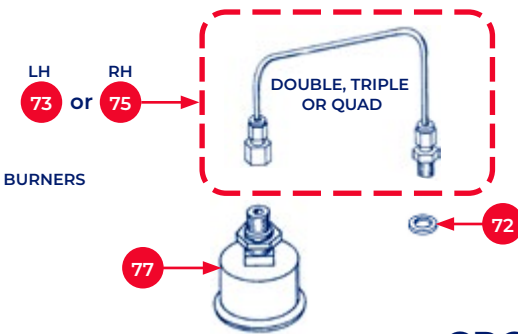

CROSSFLOW

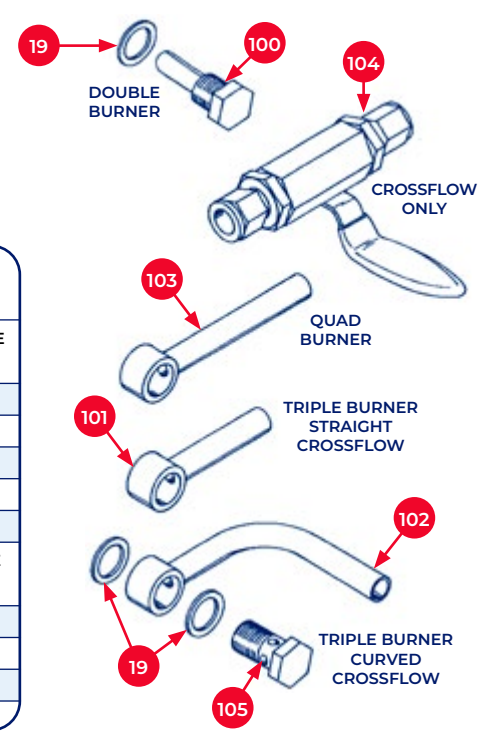

CROSSFLOW ASSEMBLIES

TRIPLE ASSEMBLY - COMPLETE	
Contains:	
101	CB-8594-0000
102	CB-8595-0000
104	CB-8598-0000
100	CB-8599-0000
19	CH-3800-0003
QUAD ASSEMBLY - COMPLETE	
Contains:	
104	CB-8598-0000
103	CB-8646-0000
100	CB-8599-0000
19	CH-3800-0003

Early Model Later Model

MAIN BLAST VALVE, CROSSFLOW, LIQUID FIRE & PRESSURE GAUGE ASSEMBLY

 <p>3 CB-8523-0000</p>	 <p>4 CB-8524-0000</p>	 <p>5 CB-8527-0000</p>	 <p>6 CB-8528-0000</p>	 <p>7 CB-8529-0000</p>	 <p>10 CB-8566-0000</p>	 <p>16 CB-8602-0000</p>	 <p>17 CB-8612-1000</p>	 <p>19 CH-3800-0003</p>
 <p>21 CU-7553-0009</p>	 <p>23 CY-0005-3025</p>	 <p>27 CY-0008-2008</p>	 <p>28 CA-0000-8227</p>	 <p>29 CA-0000-8299</p>	 <p>30 CA-0000-8300</p>	 <p>31 CB-8520-0000 FOR SINGLE STRATUS LIQUID VALVE, CONTACT CBL FOR ADVICE</p>	 <p>32 CB-8521-0000</p>	 <p>33 CB-8522-0000</p>
 <p>34 CB-8553-0000 SINGLE/DOUBLE BURNER</p>	 <p>35 CB-8554-0000 HIGH OUTPUT TRIPLE/QUAD BURNER</p>	 <p>39 CA-0000-8201</p>	 <p>72 CB-8540-0000</p>	 <p>73 CB-8551-4000 LEFTHAND</p>	 <p>75 CB-8551-5000 RIGHTHAND</p>	 <p>77 CB-8590-0000</p>	 <p>100 CB-8532-0000</p>	 <p>101 CB-8594-0000 TRIPLE BURNER - STRAIGHT</p>
 <p>102 CB-8595-0000 TRIPLE BURNER - CURVED</p>	 <p>103 CB-8646-0000 QUAD BURNER - STRAIGHT</p>	 <p>104 CB-8598-0000</p>	 <p>105 CB-8599-0000</p>	 <p>119 CB-4169-2000 FOR DOUBLE, TRIPLE BURNERS CONTACT CBL FOR ADVICE</p>				

PILOT LIGHT VALVE, IGNITER & PILOT LIGHT FLAME TUBE ASSEMBLY

LIQUID PILOT LIGHT

VAPOUR PILOT LIGHT

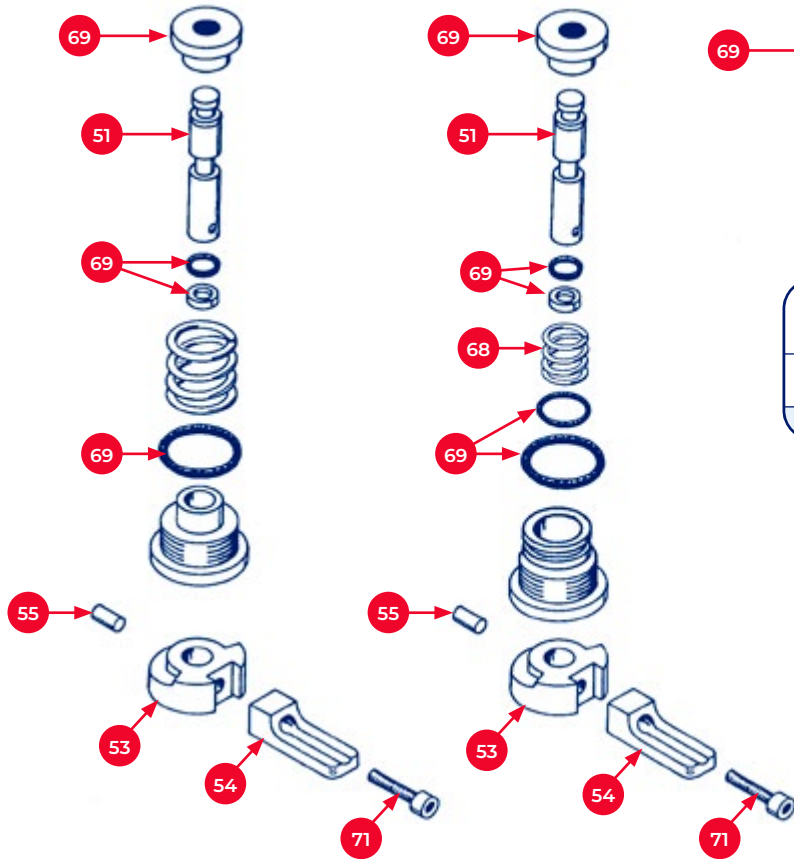

NOTES	
PILOT VALVE SEAL KIT	
69	CB-8614-1000

IGNITER

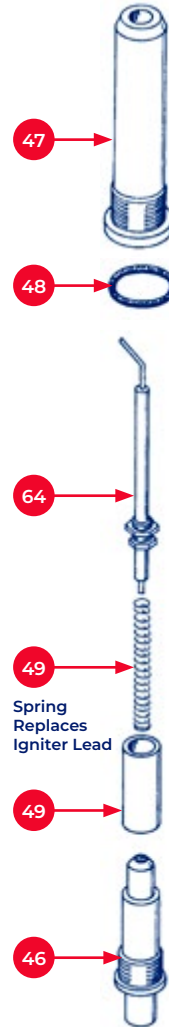

NOTES	
PILOT VAPORISER SEAL KIT	
17	CB-8624-1000
SOCKET TOOL	
113	CB-8650-1004
IGNITER TOOL	
114	CB-8650-1002

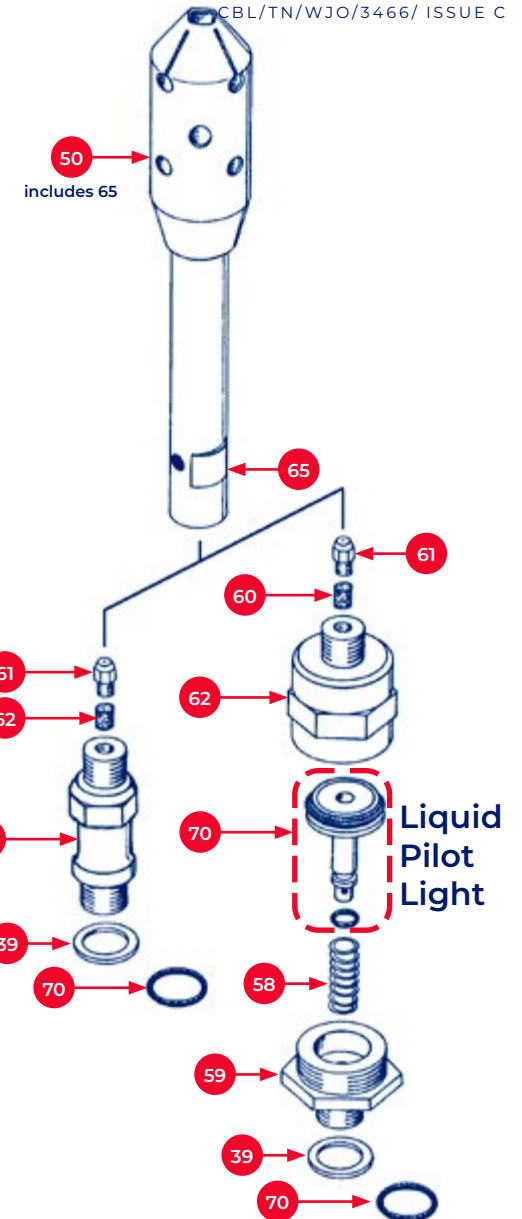

PILOT LIGHT VALVE, IGNITER & PILOT LIGHT FLAME TUBE ASSEMBLY

<p>39</p>  <p>CA-0000-8201</p>	<p>46</p>  <p>CB-8505-0000</p>	<p>47</p>  <p>CB-8506-0000</p>	<p>48</p>  <p>CB-8506-1000 IGNITER SEAL KIT</p>	<p>49</p>  <p>CB-8664-0000 REPLACES IGNITER LEAD</p>	<p>50</p>  <p>CB-8639-0000</p>	<p>51</p>  <p>CB-8511-0000</p>	<p>52</p>  <p>CB-8512-0000 REPLACED BY CB-4179-0000</p>	<p>53</p>  <p>CB-8513-0000</p>
<p>54</p>  <p>CB-8514-0000</p>	<p>55</p>  <p>CB-8515-0000</p>	<p>56</p>  <p>CB-8516-0000</p>	<p>58</p>  <p>CB-8539-0000</p>	<p>59</p>  <p>CB-8545-0000</p>	<p>60</p>  <p>CB-8546-0000</p>	<p>61</p>  <p>CB-8550-0000</p>	<p>62</p>  <p>CB-8556-0000</p>	<p>63</p>  <p>CB-8557-0000</p>
<p>64</p>  <p>CB-8561-0000</p>	<p>65</p>  <p>CB-8565-0000</p>	<p>68</p>  <p>CB-8607-0000</p>	<p>69</p>  <p>CB-8614-1000 PILOT VALVE SEAL KIT</p>	<p>70</p>  <p>CB-8624-1000 VAPOURISER SEAL KIT</p>	<p>71</p>  <p>CY-0003-3016</p>	<p>113</p>  <p>CB-8650-1004</p>	<p>114</p>  <p>CB-8650-1002</p>	

MOUNTING BRACKETS, HANDLES, COIL AND CAN ASSEMBLY

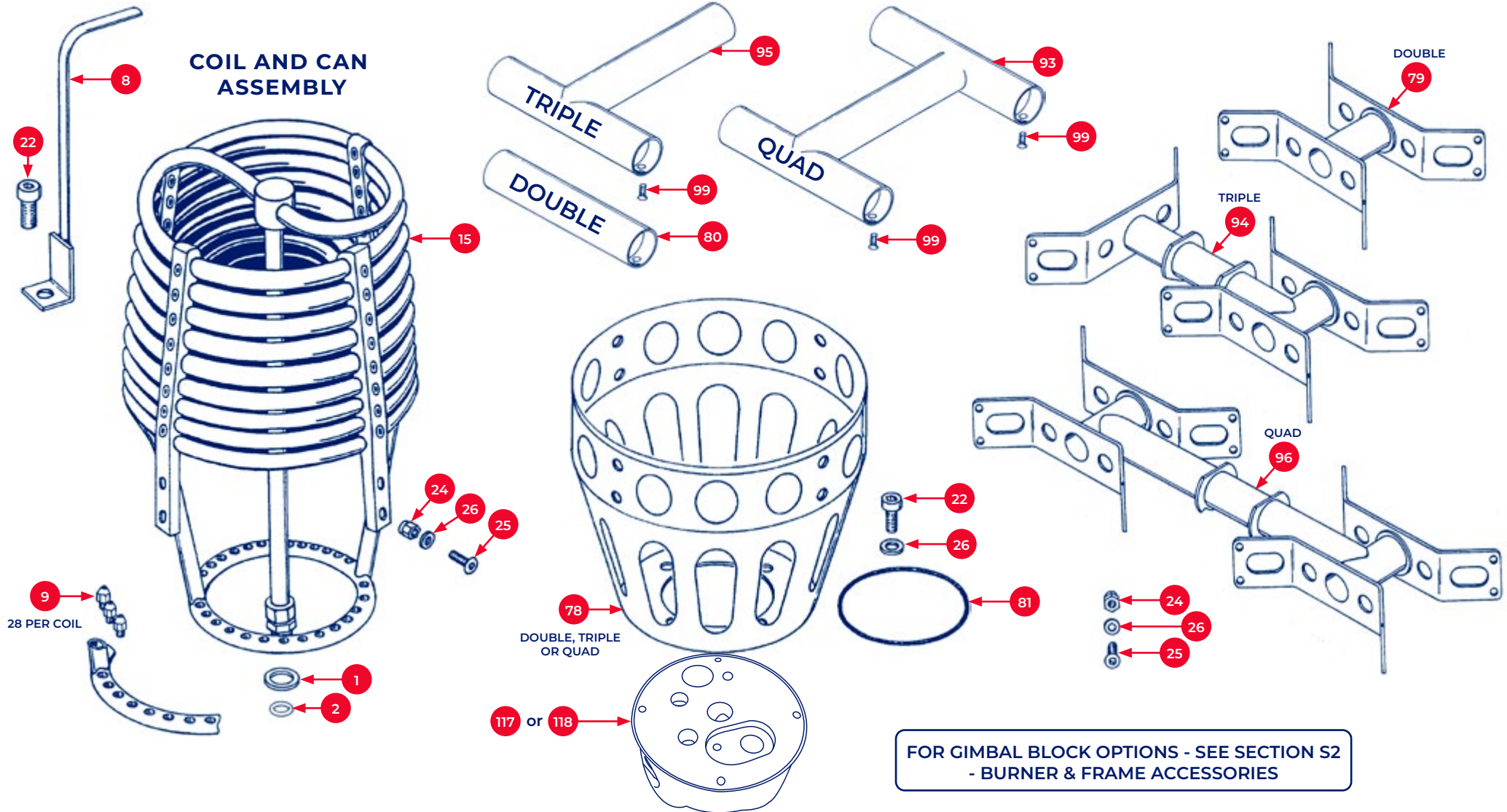

MOUNTING BRACKETS, HANDLES, COIL AND CAN ASSEMBLY

<p>1</p>  <p>CB-0392-0021</p>	<p>2</p>  <p>CB-0392-0022</p>	<p>8</p>  <p>CB-8531-0000 <i>PLEASE SPECIFY LENGTH</i></p>	<p>9</p>  <p>CB-8548-0000</p>	<p>15</p>  <p>CB-8600-0100</p>	<p>22</p>  <p>CY-0005-3014</p>	<p>24</p>  <p>CY-0005-1004</p>	<p>25</p>  <p>CY-0005-4016</p>	<p>26</p>  <p>CY-0005-2009</p>
<p>78</p>  <p>CB-8503-0000</p>	<p>79</p>  <p>CB-8504-0000</p>	<p>80</p>  <p>CB-8530-0000</p>	<p>81</p>  <p>CB-8533-0000</p>	<p>94</p>  <p>CB-8592-0000</p>	<p>95</p>  <p>CB-8593-0000</p>			
	<p>96</p>  <p>CB-8596-0000</p>	<p>99</p>  <p>CY-0003-5012</p>	<p>93</p>  <p>CB-8647-2000</p>					
<p>117</p>  <p>CB-8501-0000 <i>LEFTHAND</i></p>	<p>118</p>  <p>CB-8502-0000 <i>RIGHTHAND</i></p>							

Item	Description	Part #	Item	Description	Part #
1	TOGGLE / PIVOT PIN	CA-0000-8299	43	WHISPER VALVE (TOGGLE) WEAR PAD	CB-4164-0000
2	TOGGLE / PIVOT PIN CIRCLIP 5MM	CA-0000-8300	44	WHISPER VALVE (TOGGLE) HANDLE	CB-4166-0000
3	COPPER WASHER	CB-0214-0006	45	MAIN VALVE STEM	CB-4169-0000
4	'O' RING PACK	CB-2023-0001	46	VAPORISER OUTLET FITTING	CB-4170-0000
5	PRESSURE GAUGE SINGLE	CB-2130-0001	47	FLAME TUBE ASSEMBLY	CB-4135-0000
6	PIEZO IGNITER SPRING	CB-2767-0000	49	PILOT AIR REGULATOR TAG	CB-4174-0000
8	ELECTRODE	CB-4057-0000	50	PILOT VALVE NUT	CB-4179-0000
9	CERAMIC TUBE	CB-4058-0000	51	BLAST VALVE HOUSING	CB-4190-0000
10	WHISPER VALVE, RISER LEFTHAND	CB-4063-0000	52	BLAST VALVE SHROUD	CB-4191-0000
11	WHISPER VALVE, RISER RIGHTHAND	CB-4064-0000	53	BLAST VALVE WEAR PAD	CB-4192-0000
12	WHISPER VALVE, HANDLE	CB-4066-0000	54	BLAST VALVE HANDLE END	CB-4195-0000
13	WHISPER VALVE, RING NUT	CB-4067-0000	55	BLAST VALVES SHROUD - SINGLE	CB-4196-0000
14	WHISPER VALVE KNOB	CB-4068-0000	56	HANDLE CENTRE FITTING - SINGLE	CB-4201-0000
15	WHISPER VALVE ADJUSTER	CB-4069-0000	57	DOUBLE HANDLE	CB-4202-0000
16	WHISPER VALVE RAMP LINER	CB-4070-0000	58	TRIPLE HANDLE	CB-4203-0000
17	WHISPER VALVE DOWEL	CB-4073-0000	59	QUAD HANDLE	CB-4204-0000
18	WHISPER VALVE M5 SET SCREW	CB-4074-0000	60	HANDLE END PIECE - SINGLE - RED	CB-4205-1000
19	MAIN VALVE SEAL KIT	CB-4110-1000	61	HANDLE END PIECE - SINGLE - GREEN	CB-4205-2000
20	WHISPER VALVE SEAL KIT	CB-4110-2000	62	DOUBLE MOUNTING BRACKET	CB-4212-0000
21	PILOT VALVE SEAL KIT	CB-4110-3000	63	TRIPLE MOUNTING BRACKET	CB-4213-0000
22	IGNITER SEAL KIT	CB-4110-5000	64	QUAD MOUNTING BRACKET	CB-4214-0000
23	COIL STEM SEAL KIT	CB-4110-6000	65	TRIPLE CURVED CROSSFLOW SUB-ASSY	CB-4216-0000
24	COIL ASSEMBLY	CB-4124-0000	66	PIEZO IGNITER	CB-8505-0000
25	BLAST VALVE TRIGGER ASSEMBLY	CB-4127-0000	67	PILOT VALVE STEM	CB-8511-0000
26	WHISPER NOZZLE ASSEMBLY	CB-4131-0000	68	PILOT VALVE KNOB	CB-8513-0000
27	MAIN JETS	CB-4142-0000	69	PILOT VALVE LEVER	CB-8514-0000
28	BURNER CAN - STAINLESS STEEL	CB-4143-0000	70	PILOT VALVE DOWEL	CB-8515-0000
29	BURNER CAN - ALUMINIUM ALLOY	CB-4148-0000	71	PILOT VALVE SPRING	CB-8516-0000
30	MANIFOLD BLOCK LEFTHAND	CB-4150-0000	72	BLAST TRIGGER PIN	CB-8527-0000
31	MANIFOLD BLOCK RIGHTHAND	CB-4151-0000	73	SLURPER TUBE	CB-8531-0000
32	MANIFOLD COIL FITTING	CB-4152-0000	74	VAPORISER SPRING	CB-8539-0000
33	COIL FEED PORT PLUG	CB-4153-0000	75	GAUGE FEED COPPER WASHER	CB-8540-0000
34	IGNITER HOUSING	CB-4154-0000	76	VAPORISER INLET FITTING	CB-8545-0000
35	MANIFOLD BLOCK - SINGLE	CB-4155-0000	77	SINTERED BRONZE FILTER	CB-8546-0000
36	MANIFOLD COIL FITTING - SINGLE	CB-4156-0000	78	LIQUID PILOT LIGHT JET	CB-8550-0000
37	MANIFOLD BLOCK GASKET RING - DOUBLE/TRIPLE/QUAD - REPLACES O-RING	CB-4176-0000	79	GAUGE FEED PIPE ASSEMBLY LEFTHAND	CB-8551-4000
38	MANIFOLD BLOCK GASKET RING - SINGLE - REPLACES O-RING	CB-4198-0000	80	GAUGE FEED PIPE ASSEMBLY RIGHTHAND	CB-8551-5000
39	WHISPER VALVE HOUSING	CB-4160-0000	82	PRESSURE GAUGE	CB-8590-0000
40	WHISPER VALVE SHROUD LEFTHAND	CB-4161-0000	83	TRIPLE CROSSFLOW TUBE STRAIGHT	CB-8594-0000
41	WHISPER VALVE SHROUD RIGHTHAND	CB-4162-0000	84	STRATUS CROSSFLOW VALVE ONLY	CB-8598-0000
42	WHISPER VALVE (TOGGLE) SHROUD	CB-4163-0000	85	BANJO BOLT	CB-8599-0000

Item Description

Part #

86	COMPRESSION SPRING	CB-8602-0000
87	VAPORISER SEAL KIT	CB-8624-1000
88	QUAD CROSSFLOW TUBE	CB-8646-0000
89	3/8BSP DOWTY SEAL	CH-3800-0003
90	BLAST VALVE SPRING	CU-7553-0009
91	M3 X 16 CAP HEAD BOLT	CY-0003-3016
92	M4 X 4 SLOTTED CHEESE HD BOLT STAINLESS STEEL	CY-0004-7004
93	M5 AEROTIGHT NUT	CY-0005-1004
94	M5 SPRING WASHER	CY-0005-2007
95	M5 PLAIN WASHER	CY-0005-2008
96	M5 X 14 CAP HEAD BOLT	CY-0005-3014
97	M5 X 22 CAP HD SKT BOLT STAINLESS STEEL	CY-0005-3022
98	M5 X 25 CAP HEAD BOLT	CY-0005-3025
99	M5 X 16 BUTTON HEAD BOLT	CY-0005-4016
100	M5 X 6 GRUB SCREW HEX SOCKET (IGNITER RETAINING GRUB SCREW)	CY-0005-6006
101	M6 X 60 CAPHEAD BOLT	CY-0006-3060
102	M8 PLAIN WASHER	CY-0008-2008
103	BURNER CAN - SINGLE - ALUMINIUM	CB-4144-0000
104	MINI SINGLE CAN - ALUMINIUM	CB-4208-0000
105	MINI DOUBLE CAN - ALUMINIUM	CB-4208-0000
106	MINI COILS - NO JETS	CB-4138-0000

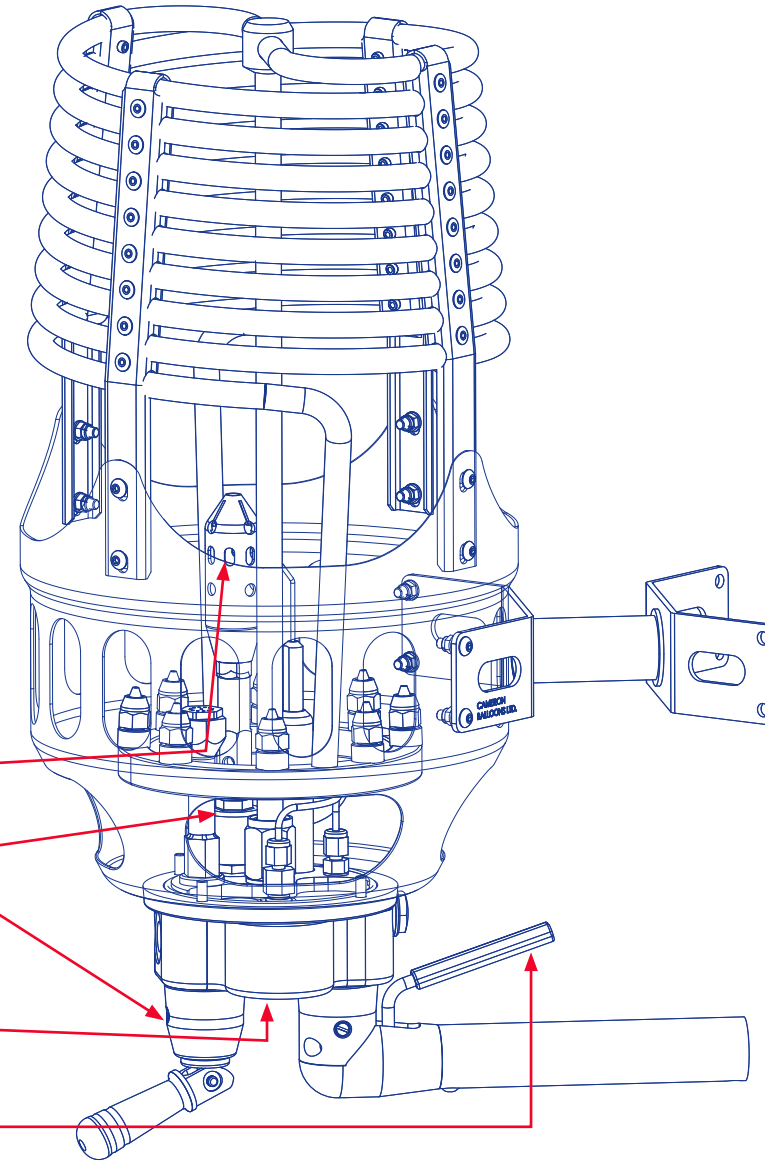

**PILOT LIGHT
PG S6-5**

**LIQUID FIRE
PG S6-3**

**PRESSURE GAUGE
PG S6-3**

**MAIN BURNER
PG S6-3, S6-5, S6-7**



MAIN BLAST VALVE, CROSSFLOW, LIQUID PILOT SYSTEM & WHISPER BURNER ASSEMBLY

LIQUID PILOT SYSTEM

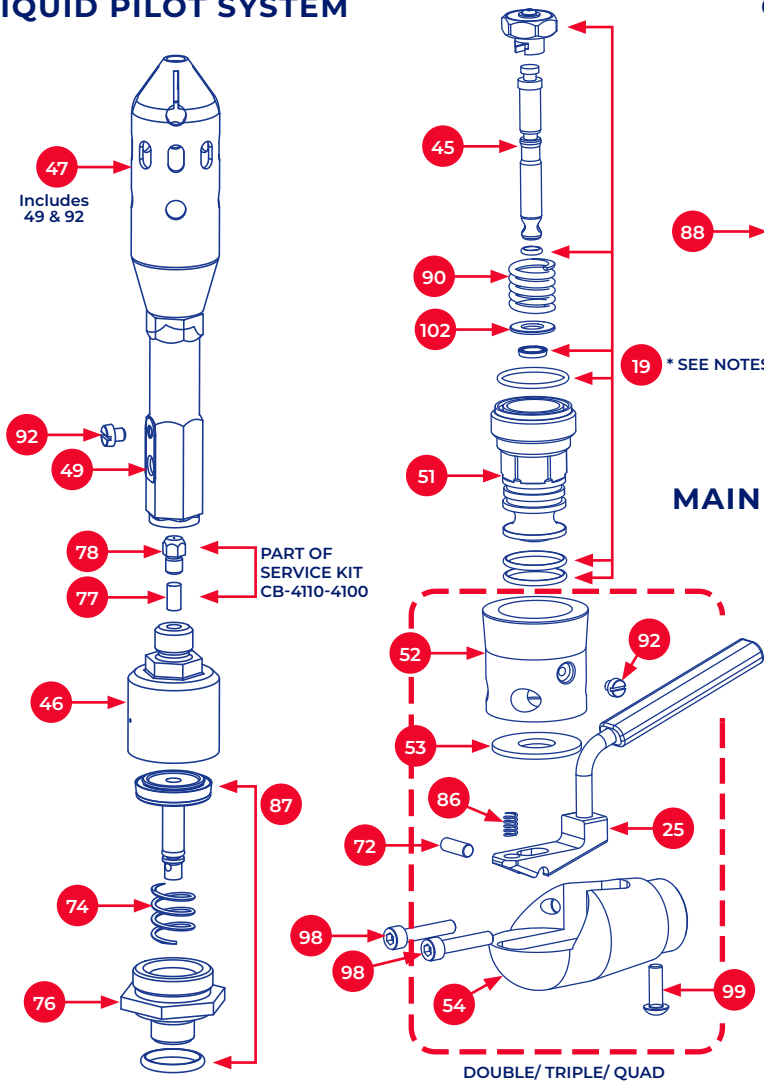

CROSSFLOW

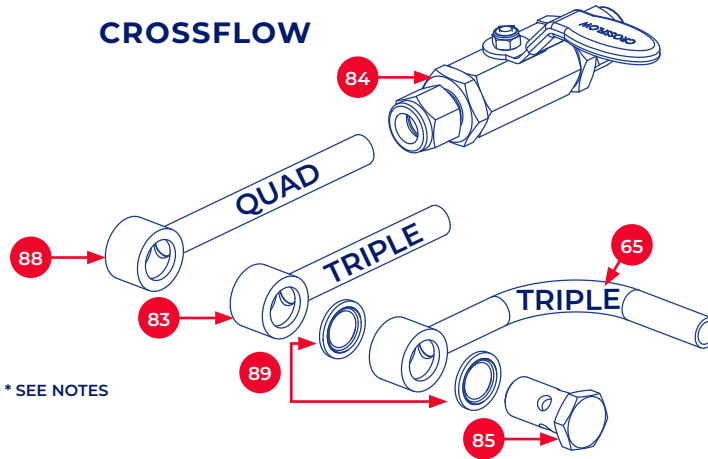

MAIN BLAST VALVE

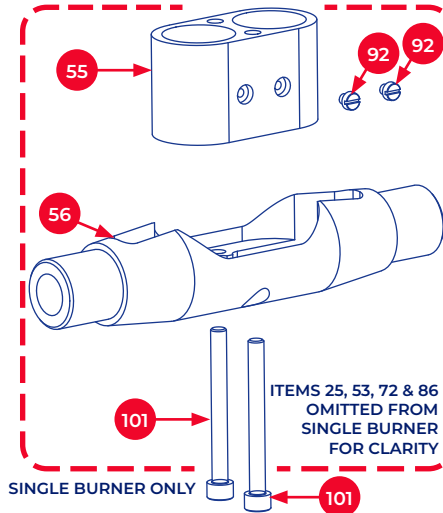

WHISPER BURNER SYSTEM

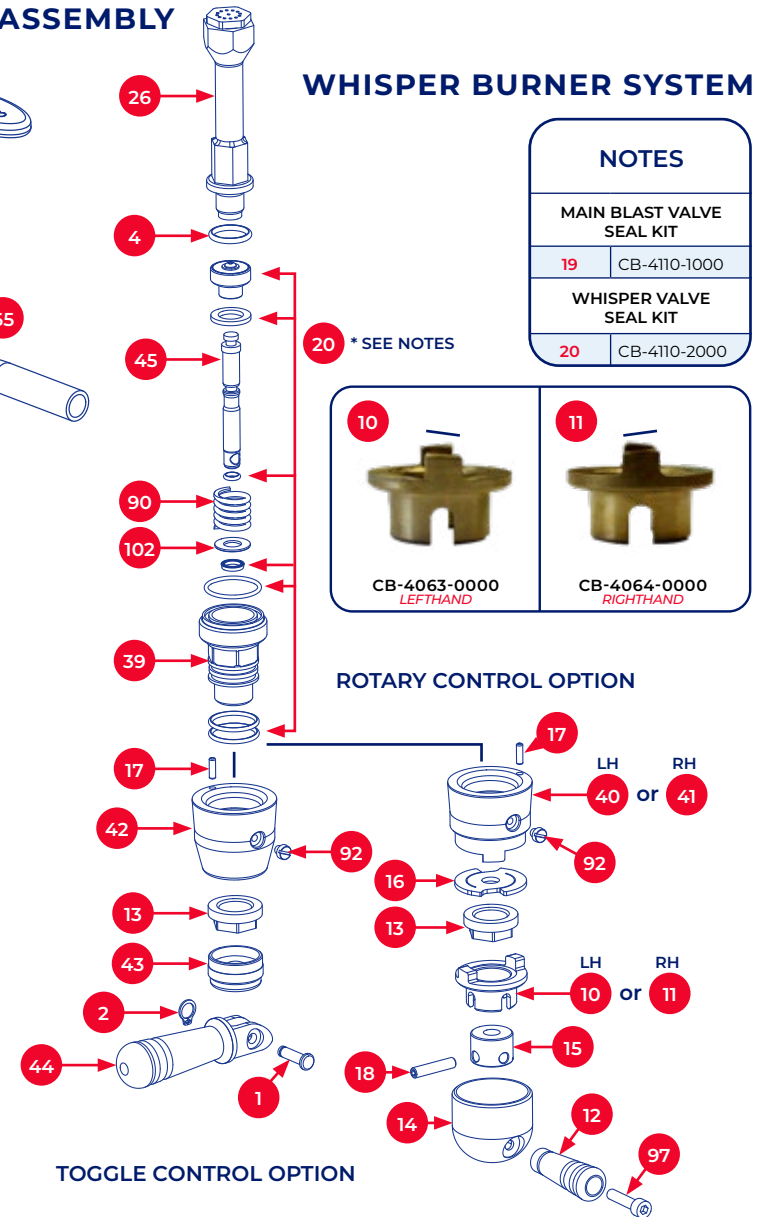

NOTES	
MAIN BLAST VALVE SEAL KIT	
19	CB-4110-1000
WHISPER VALVE SEAL KIT	
20	CB-4110-2000



ROTARY CONTROL OPTION

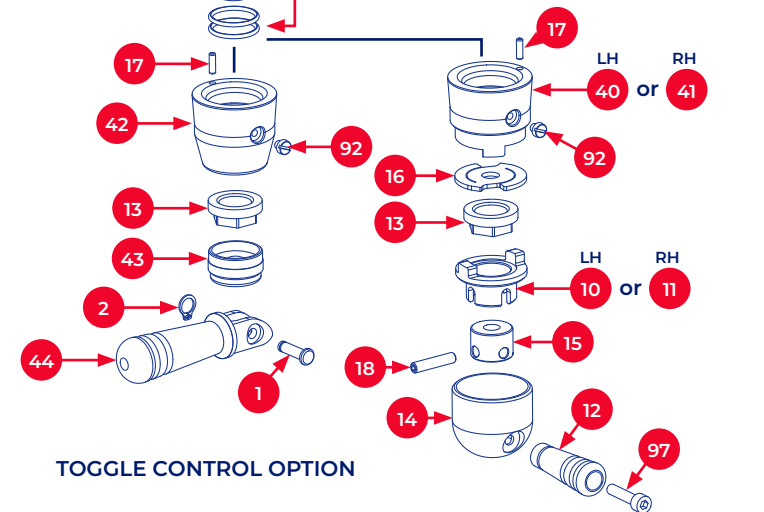

TOGGLE CONTROL OPTION

MAIN BLAST VALVE, CROSSFLOW, LIQUID PILOT SYSTEM & WHISPER BURNER ASSEMBLY

 CA-0000-8299	 CA-0000-8300	 CB-2023-0001	 CB-4066-0000	 CB-4067-0000	 CB-4068-0000	 CB-4069-0000	 CB-4070-0000	 CB-4073-0000	 CB-4074-0000
 CB-4110-1000	 CB-4110-2000	 CB-4127-0000	 CB-4131-0000	 CB-4160-0000	 CB-4161-0000 LEFTHAND	 CB-4162-0000 RIGHTHAND	 CB-4163-0000	 CB-4164-0000	 CB-4166-0000
 CB-4169-0000	 CB-4170-0000	 CB-4135-0000	 CB-4174-0000	 CB-4190-0000	 CB-4191-0000	 CB-4192-0000	 CB-4195-0000	 CB-4196-0000	 CB-4201-0000
 CB-4216-0000	 CB-8527-0000	 CB-8539-0000	 CB-8545-0000	 CB-8546-0000	 CB-8550-0000	 CB-8594-0000	 CB-8598-0000	 CB-8599-0000	 CB-8602-0000
 CB-8624-1000 VAPOURISER SEAL KIT	 CB-8646-0000	 CH-3800-0003	 CU-7553-0009	 CY-0004-7004	 CY-0005-3022	 CY-0005-3025	 CY-0005-4016	 CY-0006-3060	 CY-0008-2008

SINGLE MANIFOLD, DOUBLE/ TRIPLE/ QUAD MANIFOLD, PILOT VALVE

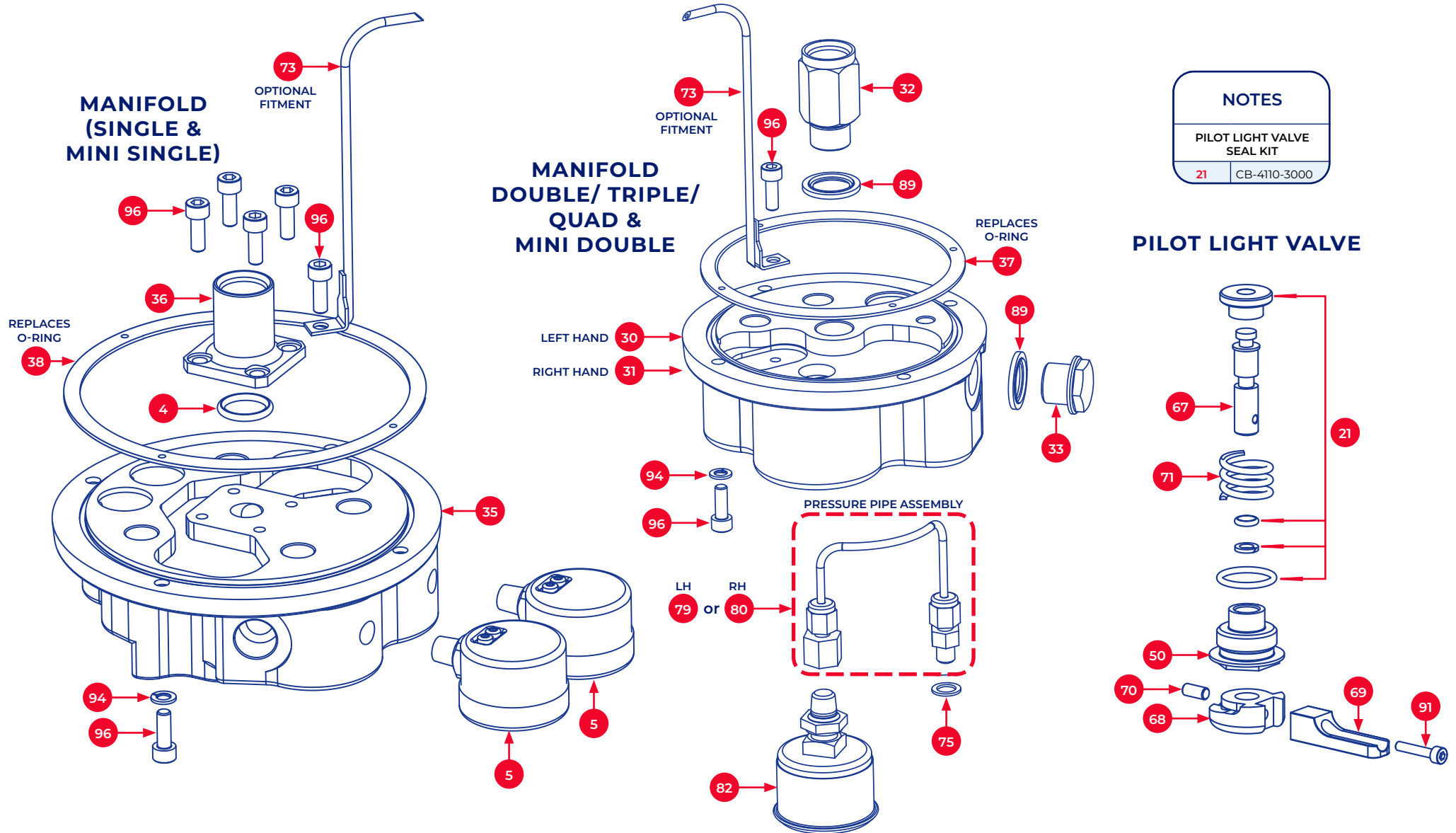







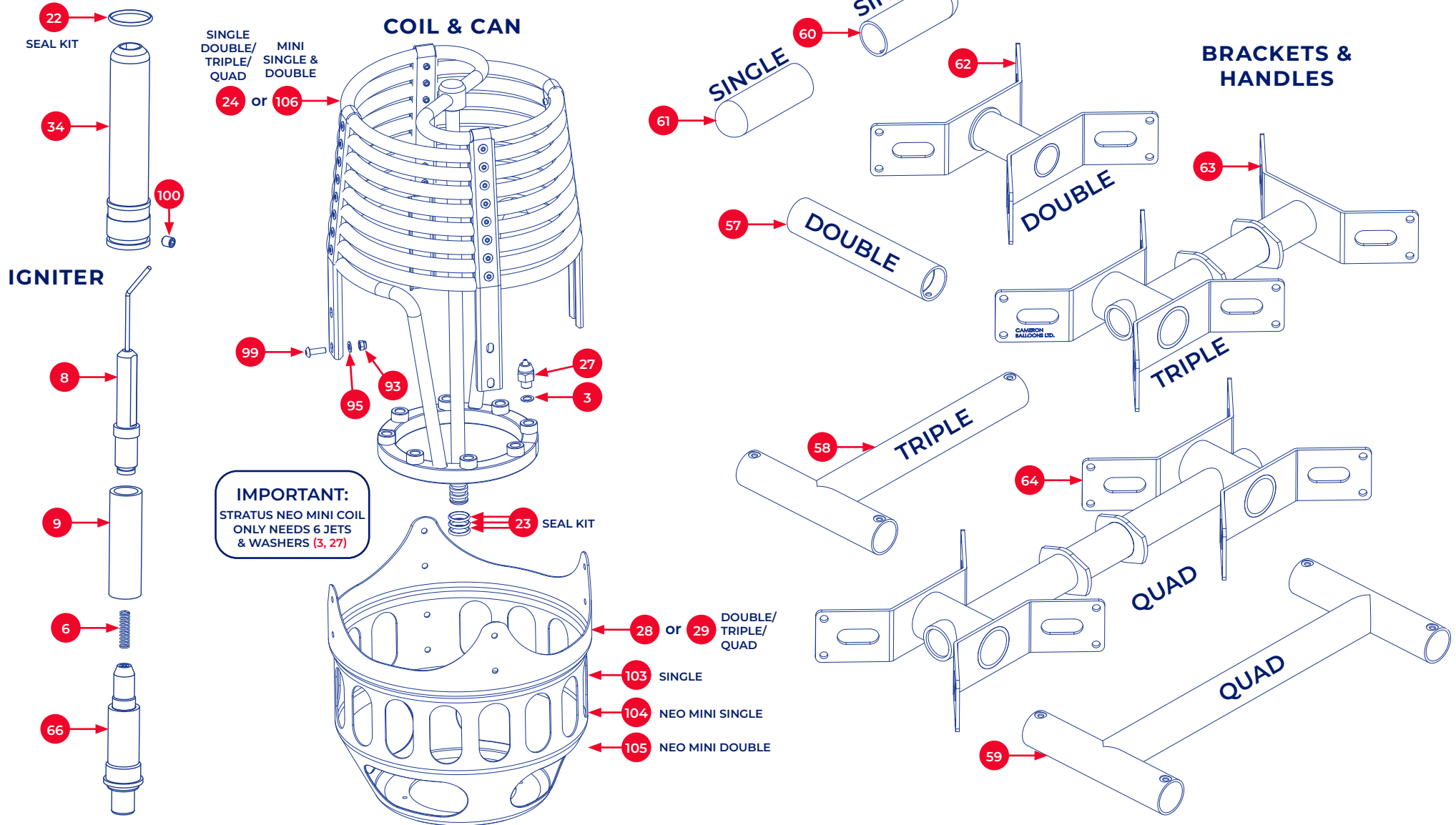





















SINGLE MANIFOLD, DOUBLE/ TRIPLE/ QUAD MANIFOLD, PILOT VALVE

<p>4</p>  <p>CB-2023-0001</p>	<p>5</p>  <p>CB-2130-0001</p>	<p>21</p>  <p>CB-4110-3000</p>	<p>30</p>  <p>CB-4150-0000 <i>LEFTHAND</i></p>	<p>31</p>  <p>CB-4151-0000 <i>RIGHTHAND</i></p>	<p>32</p>  <p>CB-4152-0000</p>	<p>33</p>  <p>CB-4153-0000</p>	<p>35</p>  <p>CB-4155-0000</p>	<p>36</p>  <p>CB-4156-0000</p>
<p>37</p>  <p>CB-4176-0000 <i>ISSUE B</i></p>	<p>38</p>  <p>CB-4198-0000 <i>ISSUE B</i></p>	<p>50</p>  <p>CB-4179-0000</p>	<p>67</p>  <p>CB-8511-0000</p>	<p>68</p>  <p>CB-8513-0000</p>	<p>69</p>  <p>CB-8514-0000</p>	<p>70</p>  <p>CB-8515-0000</p>	<p>71</p>  <p>CB-8516-0000</p>	<p>73</p>  <p>CB-8531-0000</p>
<p>75</p>  <p>CB-8540-0000</p>	<p>79</p>  <p>CB-8551-4000 <i>LEFTHAND</i></p>	<p>80</p>  <p>CB-8551-5000 <i>RIGHTHAND</i></p>	<p>82</p>  <p>CB-8590-0000</p>	<p>89</p>  <p>CH-3800-0003</p>	<p>91</p>  <p>CY-0003-3016</p>	<p>94</p>  <p>CY-0005-2007</p>	<p>96</p>  <p>CY-0005-3014</p>	

IGNITER, BRACKETS & HANDLES, COIL AND CAN ASSEMBLY



IGNITER, BRACKETS & HANDLES, COIL AND CAN ASSEMBLY

<p>3</p>  <p>CB-0214-0006</p>	<p>6</p>  <p>CB-2767-0000</p>	<p>8</p>  <p>CB-4057-0000</p>	<p>9</p>  <p>CB-4058-0000</p>	<p>22</p>  <p>CB-4110-5000</p>	<p>23</p>  <p>CB-4110-6000</p>	<p>24</p>  <p>CB-4124-0000</p>	<p>27</p>  <p>CB-4142-0000</p>	<p>28</p>  <p>CB-4143-0000</p>
<p>29</p>  <p>CB-4148-0000</p>	<p>34</p>  <p>CB-4154-0000</p>	<p>57</p>  <p>CB-4202-0000</p>	<p>58</p>  <p>CB-4203-0000</p>	<p>59</p>  <p>CB-4204-0000</p>	<p>60</p>  <p>CB-4205-1000</p>	<p>61</p>  <p>CB-4205-2000</p>	<p>62</p>  <p>CB-4212-0000</p>	<p>63</p>  <p>CB-4213-0000</p>
<p>64</p>  <p>CB-4214-0000</p>	<p>66</p>  <p>CB-8505-0000</p>	<p>93</p>  <p>CY-0005-1004</p>	<p>95</p>  <p>CY-0005-2008</p>	<p>99</p>  <p>CY-0005-4016</p>	<p>100</p>  <p>CY-0005-6006</p>	<p>103</p>  <p>CB-4144-0000</p>	<p>104</p>  <p>CB-4208-0000</p>	<p>105</p>  <p>CB-4208-0000</p>
<p>106</p>  <p>CB-4138-0000</p>								

Item	Description	Part #
3	PRESSURE GAUGE FITTING (SS-200-1-2)	CB-2472-0002
4	MAIN VALVE SPRING	CU-7553-0009
5	LIQUID PILOT LIGHT JET KIT	CB-2603-0000
6	BLAST VALVE STEM 'O' RING KIT - 10 PACK	CB-2676-0000
9	BLAST VALVE REPAIR KIT	CB-2680-0000
10	SIROCCO PILOT/WHISPER VALVE REPAIR KIT	CB-2681-0000
11	COIL END FITTING REPAIR KIT - 3 PACK	CB-2682-0000
12	PILOT LIGHT INLET FILTER REPAIR KIT	CB-2683-0000
13	LIQUID PILOT LIGHT REGULATOR REPAIR KIT	CB-2684-0000
14	COIL TO JET RING FITTING REPAIR KIT - 3 PACK	CB-2685-0000
15	REPLACEMENT BI-METAL STRIP KIT - 9 PACK	CB-2687-0000
16	PRESSURE GAUGE SEAL KIT - 2 PACK	CB-2688-0000
17	SIROCCO COIL ASSEMBLY LEFTHAND	CB-2719-1000
18	SIROCCO COIL ASSEMBLY RIGHTHAND	CB-2719-2000
22	SIROCCO GIMBAL MOUNTING BRACKET (DOUBLE)	CB-2723-0000
26	SIROCCO BLAST VALVE STEM ASSEMBLY (OLD TYPE)	CB-2730-0000
27	SIROCCO BLAST VALVE STEM ASSEMBLY	CB-2806-0000
28	BRASS RETAINING NUT, JET RING SIROCCO	CB-2732-0000
30	BLAST VALVE HANDLE (RED)	CB-2733-2734
46	PILOT LIGHT REGULATOR PISTON ASSEMBLY	CB-2754-0000
48	SIROCCO HEATER SUPPORT RING	CB-2756-0000
49	PILOT LIGHT REGULATOR HEATER ROD	CB-2757-0000
50	PILOT LIGHT FLAME TUBE LOWER ASSEMBLY	CB-2758-0000
53	PILOT LIGHT FLAME TUBE GAUZE	CB-2761-0000
56	PIEZO IGNITER CERAMIC ELECTRODE	CB-2764-0000
57	PIEZO IGNITER INSULATOR	CB-2765-0000
58	PIEZO IGNITER UNIT	CB-2766-0000
59	PIEZO IGNITER SPRING	CB-2767-0000
60	JET RING - OUTER ASSY (INC THREADED BARS & ITEM 28)	CB-2679-0000

Item	Description	Part #
61	JET RING - INNER	CB-2774-0000
62	JET RING FOIL OUTER	CB-2775-0000
63	JET RING FOIL INNER	CB-2776-0000
64	JET RING - BI-METALLIC STRIP - SINGLE (COMPLETE PACK - SEE ITEM 15)	CB-2777-0000
65	JET RING ASSEMBLY - COMPLETE	CB-2720-0000
75	WHISPER/PILOT VALVE STEM ASSY	CB-2744-0000
76	BLAST VALVE BONNET	CB-2788-0000
78	SIROCCO HANDLE CROSSBAR (DOUBLE) <i>PLEASE SPECIFY IF EXISTING HANDLE HAS GOLD SQUEEZE ACTION FOR CROSSFLOW</i>	CB-2807-1000
79	SIROCCO HANDLE CROSSBAR (TRIPLE/QUAD) <i>PLEASE SPECIFY IF EXISTING HANDLE HAS GOLD SQUEEZE ACTION FOR CROSSFLOW</i>	CB-2807-2000
109	SINTERED BRONZE FILTER	CB-8546-0000
111	PRESSURE GAUGE FITTING (SS-200-7-2)	CB-8589-0000
112	SIROCCO PRESSURE GAUGE	CB-8590-0000
113	COMPRESSION SPRING	CB-8602-0000
117	M4 PLAIN WASHER	CY-0004-2008
118	M4 X 6 PAN HEAD BOLT	CY-0004-4006
121	M5 AEROTIGHT NUT	CY-0005-1004
123	M5 STAINLESS STEEL SPRING LOCK WASHER	CY-0005-2007
124	M5 PLAIN WASHER	CY-0005-2008
125	M5 X 16 HEX SOCKET CAP HEAD SCREW	CY-0005-3016
132	M6 X 25 CAP HEAD BOLT HEX SOCKET	CY-0006-3025
133	M6 X 6 GRUB SCREW HEX SOCKET	CY-0006-6006
134	M8 PLAIN WASHER	CY-0008-2008
135	SIROCCO SPANNER	CB-2748-0000
136	LUBE SCREW 'O' RINGS	CB-2609-0000
137	M5 X 16 HEX SOCKET CAP HEAD SCREW	CY-0005-3020
138	SIROCCO REMOTE CONTROL BLAST VALVE SEAL KIT	CB-2678-0000

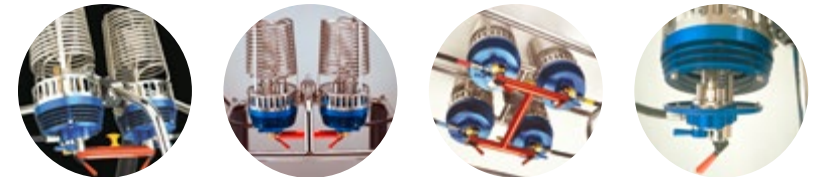

MAIN BLAST, PILOT LIGHT AND WHISPER VALVES

IMPORTANT:
 VALVE BLOCK SERIAL NO. 0048 & BELOW, SOME PARTS ARE DIFFERENT.
 FOR FURTHER INFORMATION, PLEASE CONTACT:
AFTERSALES@CAMERONBALLOONS.CO.UK

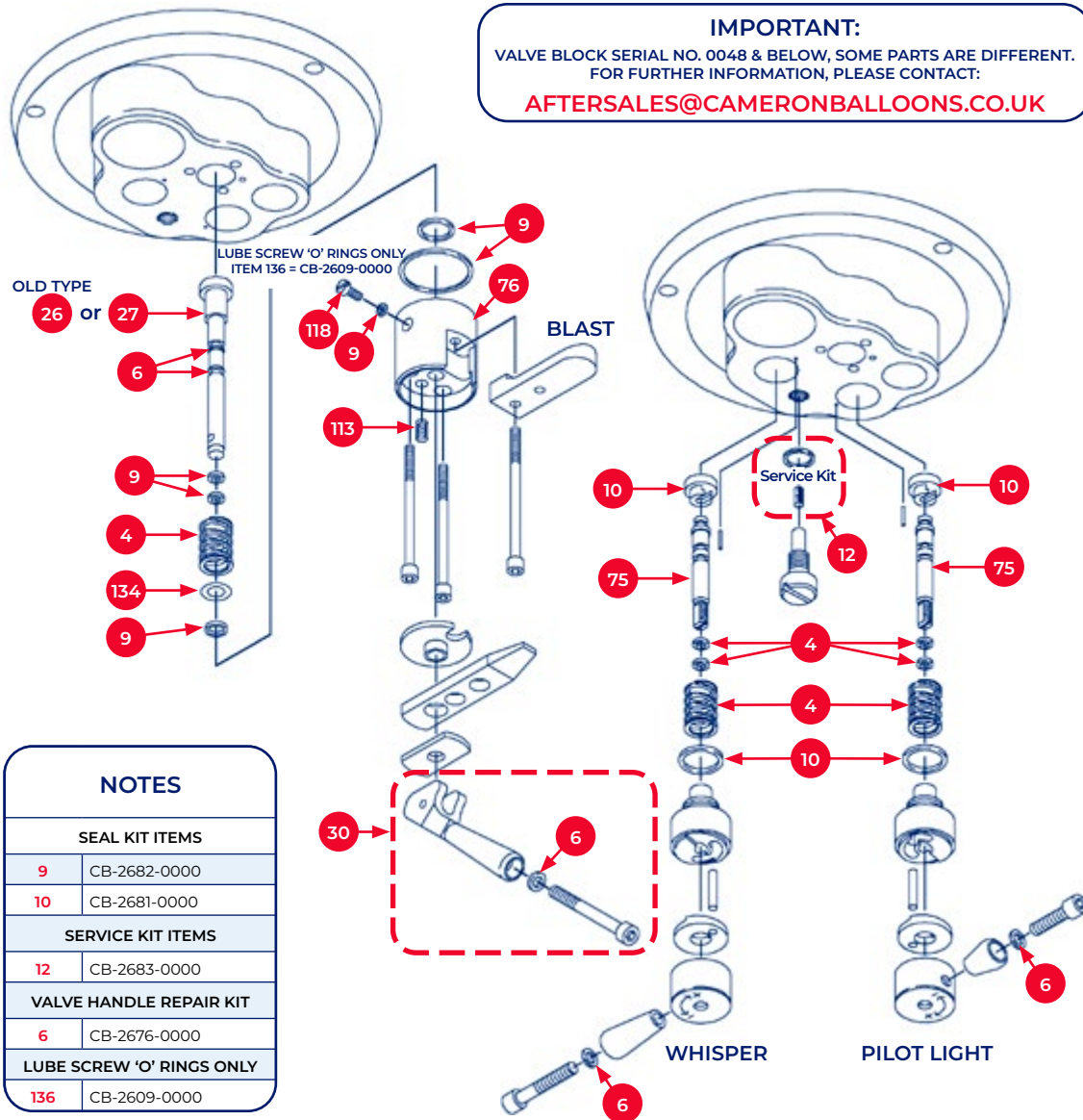

NOTES	
SEAL KIT ITEMS	
9	CB-2682-0000
10	CB-2681-0000
SERVICE KIT ITEMS	
12	CB-2683-0000
VALVE HANDLE REPAIR KIT	
6	CB-2676-0000
LUBE SCREW 'O' RINGS ONLY	
136	CB-2609-0000

 CU-7553-0009	 10 Pack CB-2676-0000	 CB-2680-0000	 CB-2681-0000
 CB-2683-0000	 CB-2730-0000 OLD TYPE	 CB-2806-0000	 CB-2733-2734
 CB-2744-0000	 CB-2788-0000	 CB-8602-0000	 CY-0004-4006
 CY-0008-2008	 CB-2609-0000 LUBE SCREW 'O' RINGS		

PILOT LIGHT, WHISPER JET SLEEVE, PIEZO IGNITER & PRESSURE GAUGE

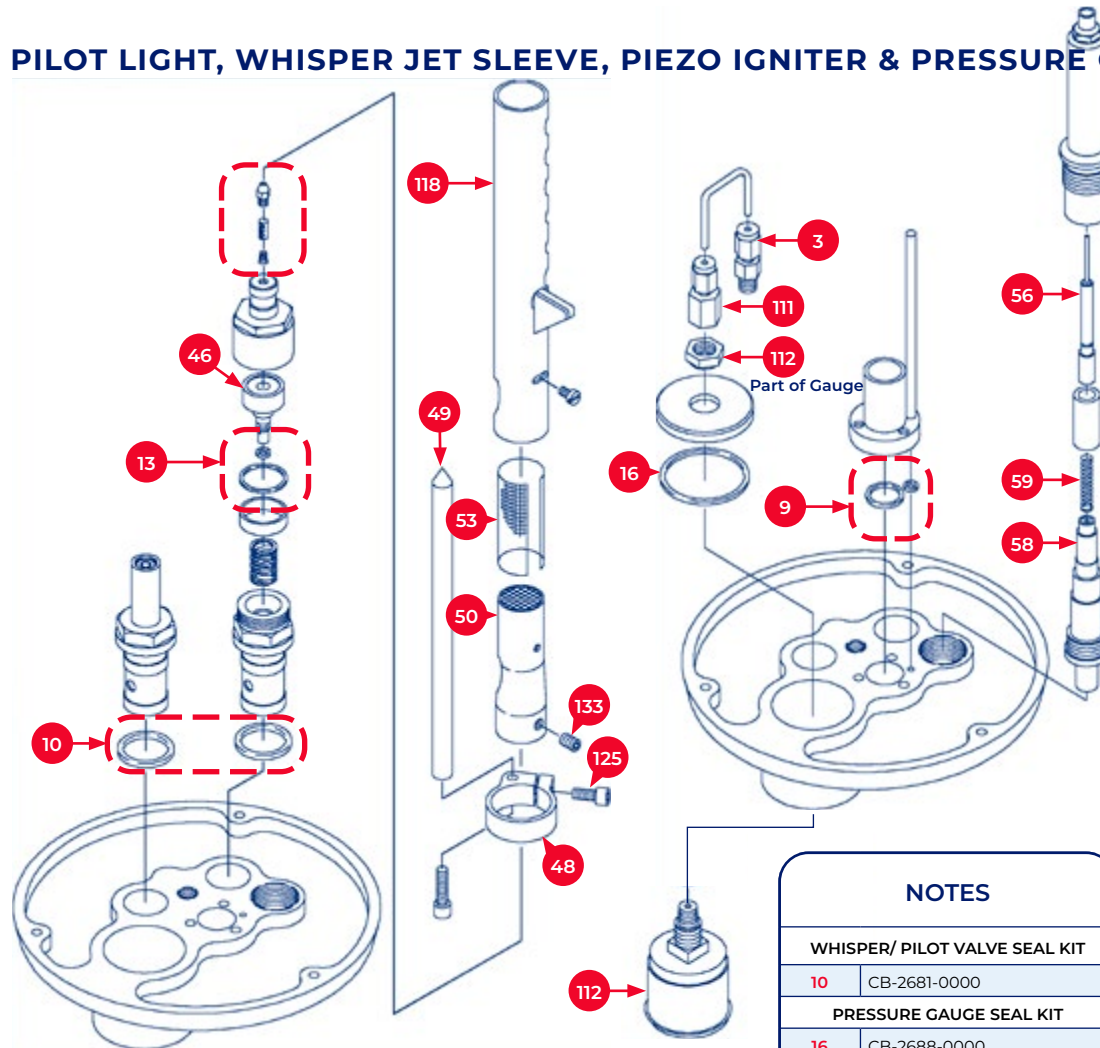

NOTES	
WHISPER/ PILOT VALVE SEAL KIT	
10	CB-2681-0000
PRESSURE GAUGE SEAL KIT	
16	CB-2688-0000
PILOT LIGHT REGULATOR SEAL KIT	
13	CB-2684-0000
PILOT LIGHT JET/ FILTER SERVICE KIT	
5	CB-2603-0000
BLAST VALVE SEAL KIT	
9	CB-2680-0000

 3 CB-2472-0002	 5 CB-2603-0000	 9 CB-2680-0000	 10 CB-2681-0000
 13 CB-2684-0000	 16 CB2688-0000	 46 CB-2754-0000	 48 CB-2756-0000 <i>INC. ITEM 125</i>
 49 CB-2757-0000	 50 CB-2758-0000	 53 CB-2761-0000	 56 CB-2764-0000
 57 CB-2765-0000	 58 CB-2766-0000	 59 CB-2767-0000	 111 CB-8589-0000
 133 CY-0006-6006	 112 CB-8590-0000	 118 CY-0004-4006	 125 CY-0005-3016

COIL, CAN & JET ASSEMBLY

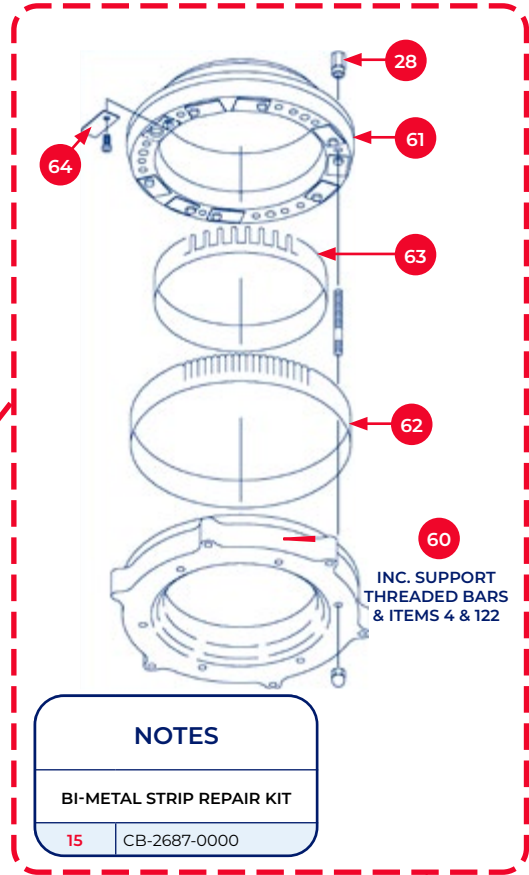
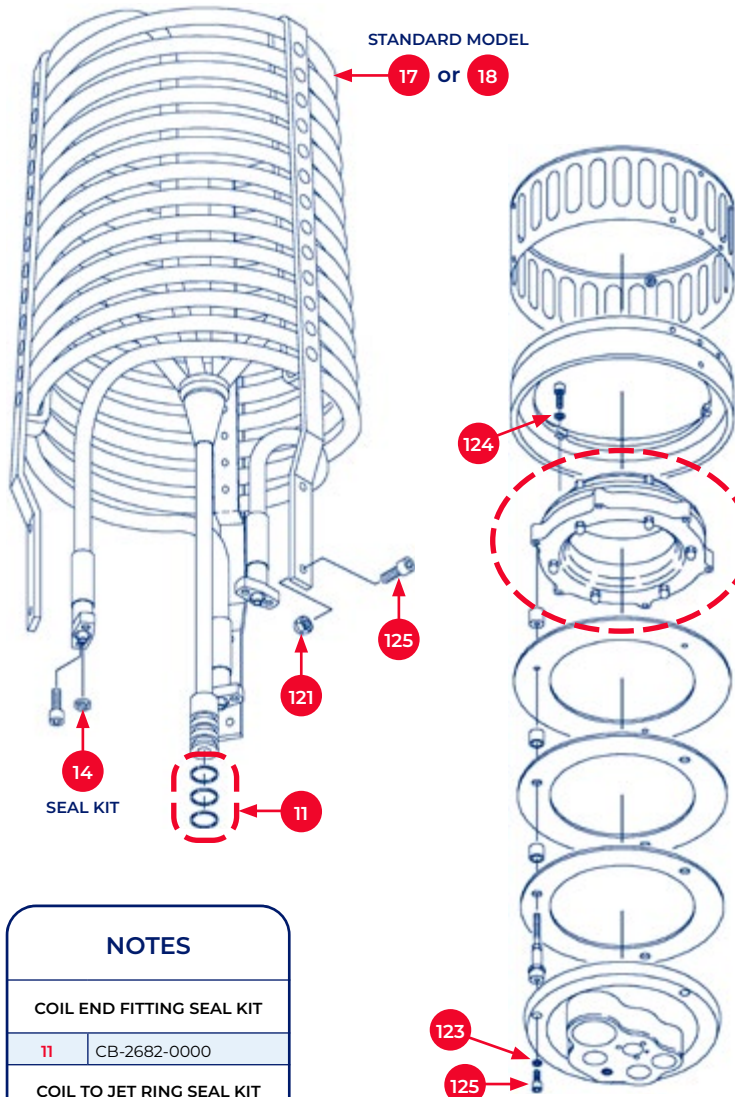

NOTES	
BI-METAL STRIP REPAIR KIT	
15	CB-2687-0000

NOTES	
COIL END FITTING SEAL KIT	
11	CB-2682-0000
COIL TO JET RING SEAL KIT	
14	CB-2685-0000

<p>11</p> <p>CB-2682-0000</p>	<p>14</p> <p>CB-2685-0000</p>	<p>15</p> <p>CB-2687-0000</p>
<p>17</p> <p>CB-2719-1000 LEFTHAND</p>	<p>18</p> <p>CB-2719-2000 RIFTHAND</p>	<p>28</p> <p>CB-2732-0000</p>
<p>64</p> <p>CB-2777-0000 SEE ITEM 15 FOR PACK</p>	<p>60</p> <p>CB-2679-0000 INC. SUPPORT THREADED BARS & ITEM 28</p>	<p>65</p> <p>CB-2720-0000 COMPLETE JET RING</p>
<p>121</p> <p>CY-0005-1004</p>	<p>123</p> <p>CY-0005-2007</p>	<p>124</p> <p>CY-0005-2008</p>
<p>125</p> <p>CY-0005-3016</p>		

HANDLE AND MOUNTING ASSEMBLY

FOR GIMBAL BLOCK OPTIONS - SEE SECTION S2
- BURNER & FRAME ACCESSORIES

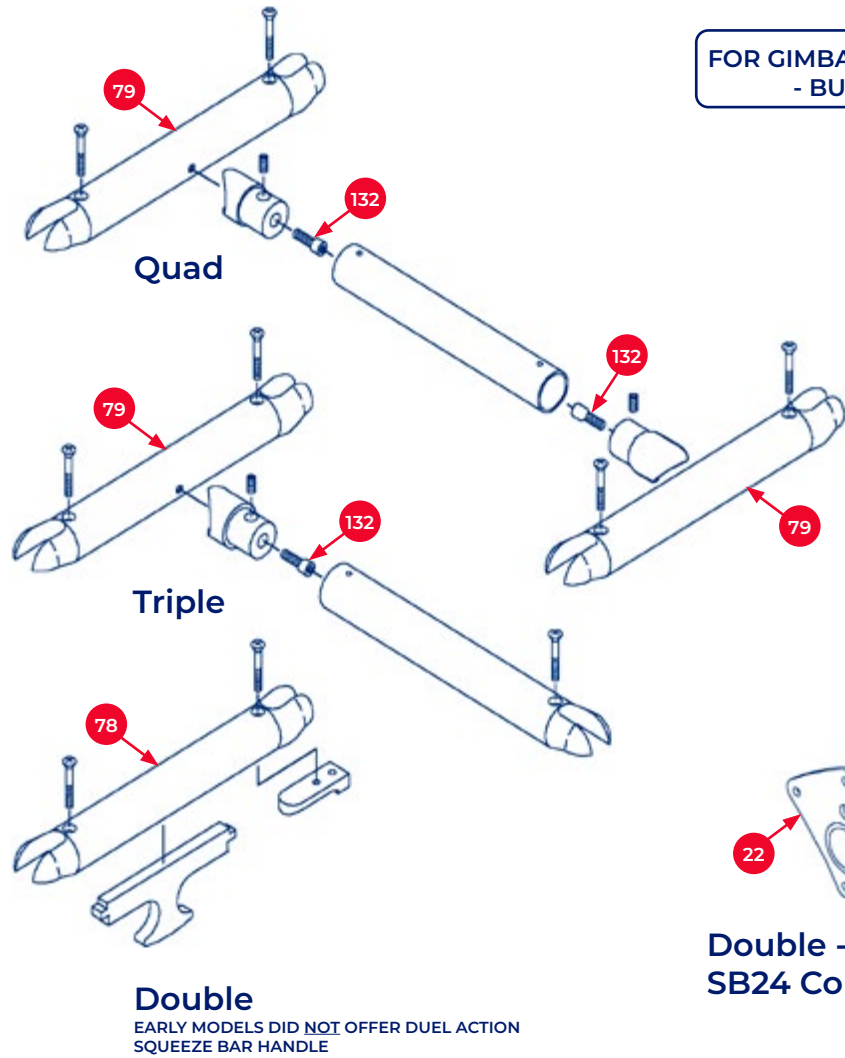

<p>22</p> <p>CB-2723-0000 SB-24 COMPLIANT</p>		
<p>78</p> <p>CB-2807-1000 DOUBLE ONLY</p>		
<p>79</p> <p>CB-2807-2000 TRIPLE/QUAD</p>		
<p>121</p> <p>CY-0005-1004</p>	<p>125</p> <p>CY-0005-3016</p>	<p>132</p> <p>CY-0006-3025</p>
<p>135</p> <p>CB-2748-0000</p>	<p>137</p> <p>CY-0005-3020</p>	

EP BLAST VALVE SLEEVE ASSEMBLY

IMPORTANT:

For advice on missing parts please contact:
AFTERSALES@CAMERONBALLOONS.CO.UK

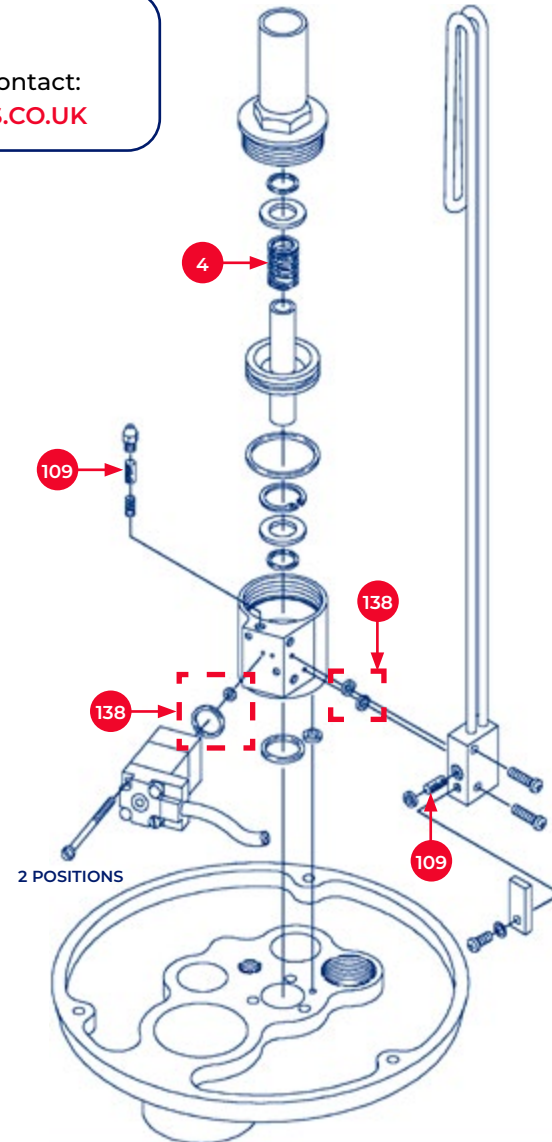

Item	Description	Part #
1	AMAL MAIN JET	CB-0214-0003
2	COPPER WASHER	CB-0214-0006
3	3/8 BSP SEALING RING - OUTER	CB-0392-0021
4	3/8 BSP SEALING RING - INNER	CB-0392-0022
5	SADDLE - <i>Ø19MM TUBE (PLEASE SPECIFY - 4.76, 6.35, 11.11 OR 15.9MM)</i>	CB-0543-0004
6	WHISPER VALVE (RIGHT HAND)	CB-0558-0001
7	WHISPER VALVE (LEFT HAND)	CB-0558-0002
8	3/8 OD CROSSFLOW ASSEMBLY <i>CONTACT CAMERON BALLOONS FOR ADVICE</i>	CB-0578-0000
9	MK4 SUPER COIL (NO JETS - PLEASE SPECIFY LH OR RH)	CB-0584-2000
10	WHISPER JET & ADAPTOR	CB-0924-0001
12	M8 SPECIAL SCREW FOR BURNER CAN	CB-0737-0000
14	MULTI HOLE MAIN JET	CB-0923-0001
15	LEAK DUCT TUBE	CB-2140-0000
16	PILOT LIGHT SLEEVE	CB-2493-0000
17	PILOT LIGHT SERVICE KIT - 5 PKT	CB-2605-0000
18	VAPOUR PILOT LIGHT SERVICE KIT	CB-2606-0000
19	BLAST VALVE MAIN SEAL SERVICE KIT	CB-2607-0000
20	BLAST VALVE SERVICE KIT	CB-2611-0000
22	MK4 SUPER PRESSURE GAUGE	CB-2887-0000
23	PRESSURE GAUGE LENS KIT - INC. SCREW	CU-2948-0002
24	LEAK DUCT TUBE	CU-4870-6000
25	MAIN VALVE PIVOT PIN	CU-4870-8000
26	HANDLE GRUB SCREW	CU-4870-9000
27	MAIN VALVE WASHER	CU-4871-0000
28	MAIN VALVE STEM	CU-4870-1000
29	MAIN VALVE SHUTTER	CU-4871-3000

Item	Description	Part #
30	MAIN VALVE LUBE SCREW	CU-4871-8000
31	PILOT VALVE STEM (2 VARIANTS AVAILABLE) <i>PLEASE SPECIFY IF EXISTING HANDLE HAS A WELDED NUT OR A FREE NUT</i>	CU-4872-2000
32	PILOT VALVE SPRING	CU-4872-4000
33	PILOT VALVE HANDLE (LEFT HAND) <i>REPLACES WELDED TYPE HANDLE - MAY ALSO REQUIRE ITEM 31 CONTACT FOR ADVICE</i>	CU-4872-5001
34	PILOT VALVE HANDLE (RIGHT HAND) <i>REPLACES WELDED TYPE HANDLE - MAY ALSO REQUIRE ITEM 31 CONTACT FOR ADVICE</i>	CU-4872-6001
35	PILOT LIGHT FLAME TUBE	CU-4872-9000
36	PILOT LIGHT JET	CU-4873-0000
37	PILOT LIGHT FLAME CUP <i>LEFTHAND + RIGHTHAND - CONTACT FOR ADVICE</i>	CU-4873-1000
38	IGNITER ASSEMBLY COMPLETE	CU-4873-3001
39	BLAST VALVE SPRING	CU-7553-0009
40	M5 X 16 RAISED CSK HEAD (SLOTTED)	CY-0005-5016
41	M6 X 10 CAP HEAD BOLT HEX SOCKET	CY-0006-3010
42	M6 X 20 CAP HEAD BOLT HEX SOCKET	CY-0006-3020
43	M6 X 6 GRUB SCREW HEX SOCKET	CY-0006-6006
45	M8 X 50 HEX HEAD BOLT	CY-0008-0050
46	M8 LOCK NUT	CY-0008-1003
47	M8 DOME NUT	CY-0008-1006
48	M8 PLAIN WASHER	CY-0008-2008
49	LUBE SCREW 'O' RINGS - 5 PKT	CB-2609-0000
50	2 X M6 X 6 GRUB SCREW HEX SOCKET - FLAT	CU-4872-8000
51	2 X M6 X 6 GRUB SCREW HEX SOCKET - POINTED	CU-4873-2000
52	SMALL PRESSURE GAUGE LENS	CB-2887-0001

ENVELOPE COMPONENTS & ACCESSORIES

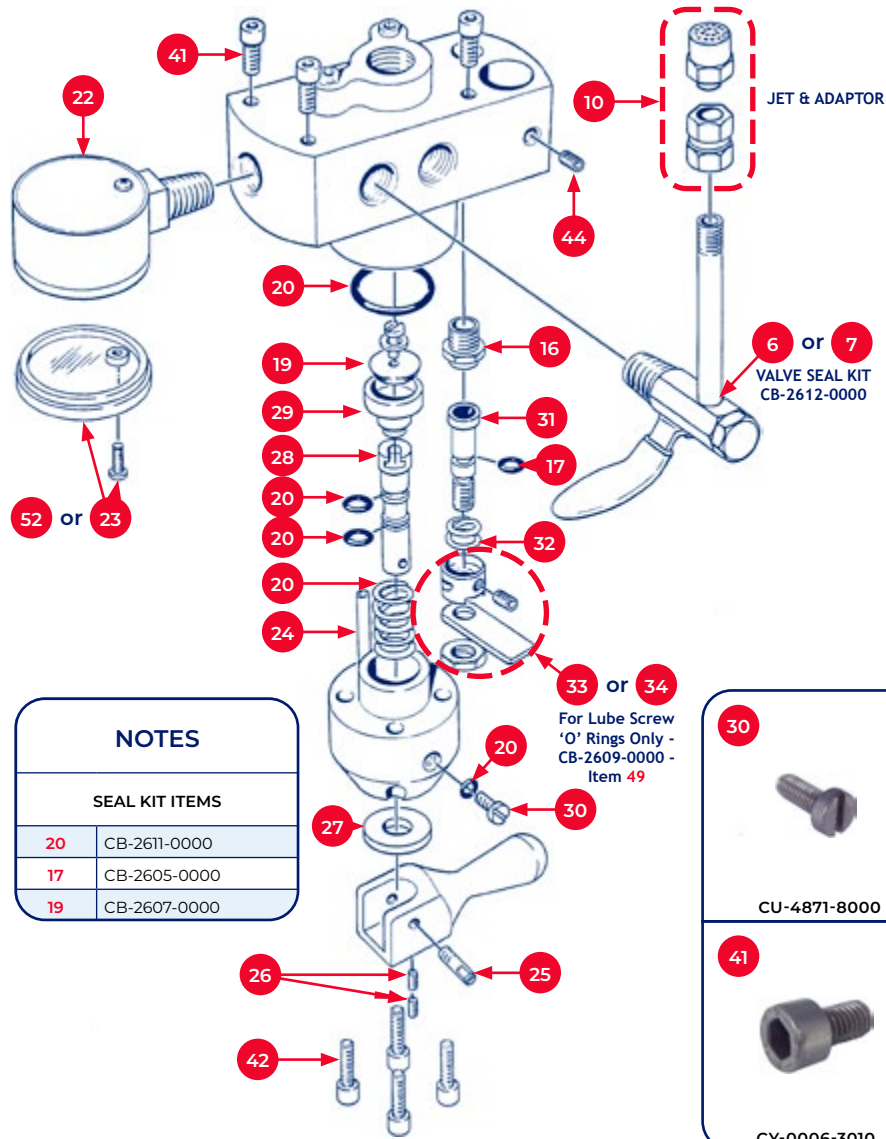

NOTES

SEAL KIT ITEMS

20	CB-2611-0000
17	CB-2605-0000
19	CB-2607-0000

 CB-0558-0001	 CB-0558-0002	 CB-0588-0003	 CB-2493-0000	 CB-2605-0000 PILOT LIGHT SERVICE KIT
 CB-2607-0000 BLAST VALVE MAIN SEAL KIT	 CB-2611-0000 BLAST VALVE SERVICE KIT	 CB-2887-0000	 CU-2948-0002 INC. SCREW	 CU-4870-8000
 CU-4871-0000	 CU-4870-9000	 CU-4871-0000	 CU-4870-1000	 CU-4871-3000
 CU-4871-8000	 CU-4872-2000 PLEASE SPECIFY IF EXISTING HANDLE HAS A WELDED NUT OR A FREE NUT	 CU-4872-4000	 CU-4872-5001 REPLACES WELDED NUT HANDLE - MAY ALSO REQUIRE ITEM 31 - CONTACT FOR ADVICE	 CU-4872-6001 REPLACES WELDED NUT HANDLE - MAY ALSO REQUIRE ITEM 31 - CONTACT FOR ADVICE
 CU-7553-0009	 CY-0006-3010	 CY-0006-3020	 CB-2609-0000 LUBE SCREW 'O' RINGS	 CU-4872-8000 Flat
 CU-4872-2000 Pointed	 CB-2887-0001			

DOUBLE/TRIPLE/QUAD MANIFOLD, COIL, JETS, CROSSFLOW AND HANDLE FITTINGS

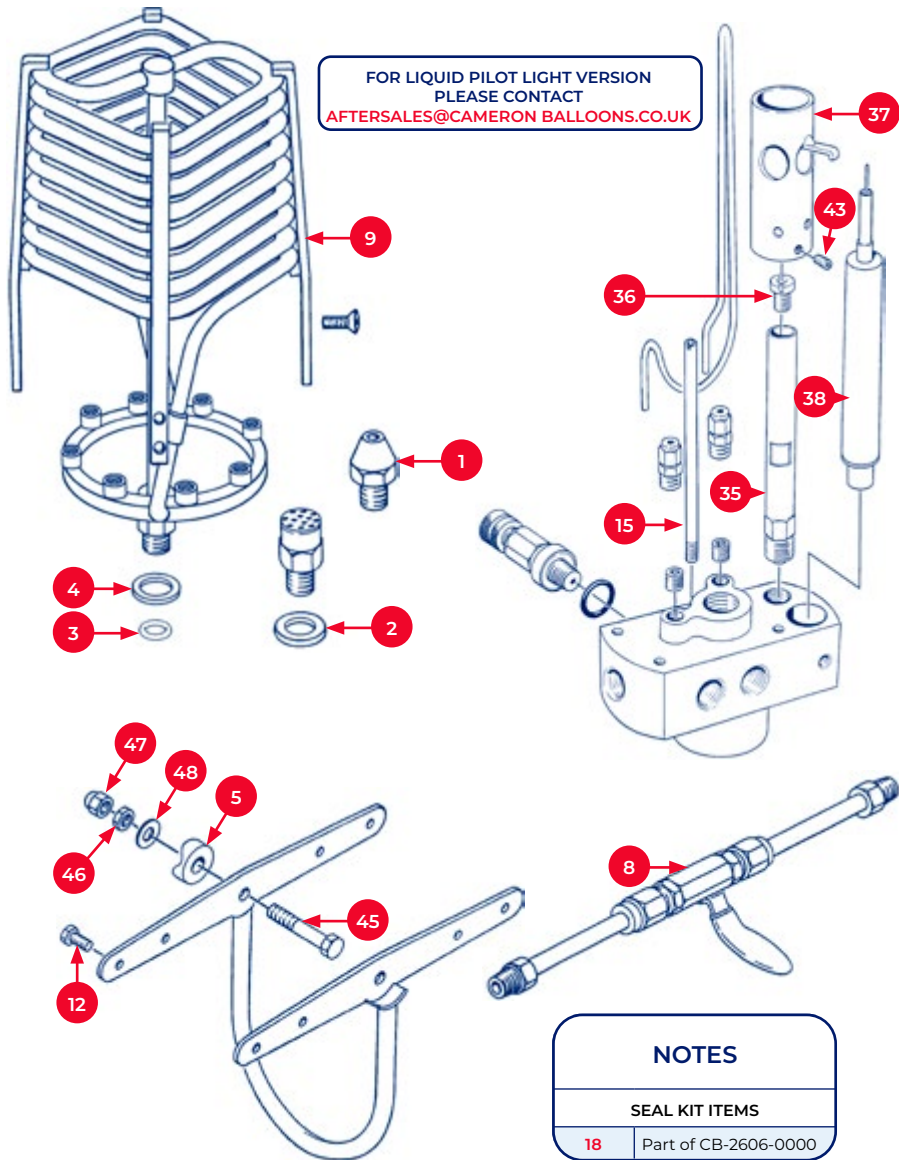

<p>1</p> <p>CB-0214-0003</p>	<p>2</p> <p>CB-0214-0006</p>	<p>3</p> <p>CB-0392-0021</p>	<p>4</p> <p>CB-0392-0021</p>	<p>5</p> <p>CB-0543-0004 <i>PLEASE SPECIFY TUBE Ø</i></p>
<p>8</p> <p>CB-0578-0000</p>	<p>9</p> <p>CB-0584-2000 <i>(NO JETS) SPECIFY LH OR RH</i></p>	<p>12</p> <p>CB-0737-0000</p>	<p>14</p> <p>CB-0923-0001</p>	
<p>15</p> <p>CB-2140-0000</p>	<p>18</p> <p>CB-2606-0000</p>	<p>35</p> <p>CU-4872-9000</p>	<p>36</p> <p>CU-4873-0000</p>	<p>37</p> <p>CU-4873-1000</p>
<p>38</p> <p>CU-4873-3001</p>	<p>40</p> <p>CY-0005-5016</p>	<p>43</p> <p>CY-0006-6006</p>	<p>45</p> <p>CY-0008-0050</p>	
<p>46</p> <p>CY-0008-1003</p>	<p>47</p> <p>CY-0008-1006</p>	<p>48</p> <p>CY-0008-2008</p>		

Item	Description	Part #
2	WORCESTER BALL VALVE	CB-0392-0017
3	WORCESTER BALL VALVE HANDLE LEFTHAND	CA-0000-8145
4	WORCESTER BALL VALVE HANDLE RIGHTHAND	CA-0000-8145
5	WOOD HANDLE TRIM LIGHT	CA-0000-8146
9	WOOD HANDLE TRIM DARK	CA-0000-8146
10	M6 X 10 CAP HEAD BOLT	CY-0006-3010
11	M6 WASHER	CY-0006-2008
12	M6 NYLOC NUT	CY-0006-1002
13	M6 X 90 BOLT	CY-0006-0090
19	TYPE 1520 MAIN JET	CA-0000-8014
20	MULTIHOLE MAIN JET (RETROFIT OPTION)	CA-0000-8345
21	WORCESTER VALVE SEAL KIT FOR ITEM 2	CB-0392-0018
22	1/8 NPT X 8MM COMPRESSION FITTING	CA-0000-8165
25	3/4 BSP COPPER GASKET	CA-0000-8201
26	3/4 BSP DYNAQUIP BALL VALVE	CA-0000-8049
27	DYNAQUIP VALVE HANDLE (RED)	CA-0000-8140
31	3/4 BSP SPACER	CA-0000-8064
35	TYPE 3060 JET	CA-0000-8136
42	3/4 BSP KLINGER VALVE RIGHTHAND	CA-0000-8017
47	C2 PILOT FLAME TUBE	CA-0000-8023
48	PIEZO IGNITER	CA-0000-8105
49	IGNITER HOUSING	CA-0000-8020
52	CONE HOUSING	CA-0000-8052
57	ELECTRODE MOUNTING BRACKET	CA-0000-8031
58	M5 X 10 BOLT	CY-0005-0010
65	M6 X 25 BOLT	CY-0006-0025
67	M6 AEROTIGHT LOCK NUT	CY-0006-1004
69	12MM X 60MM STANDPIPE	CA-0000-8044
70	3/8 BSP COPPER GASKET	CA-0000-8198
71	3/8 BSP DYNAQUIP BALL VALVE	CA-0000-8147
72	DYNAQUIP VALVE HANDLE (GREEN)	CA-0000-8141
73	NO6 X 1/2" SCREW	CA-0000-8184

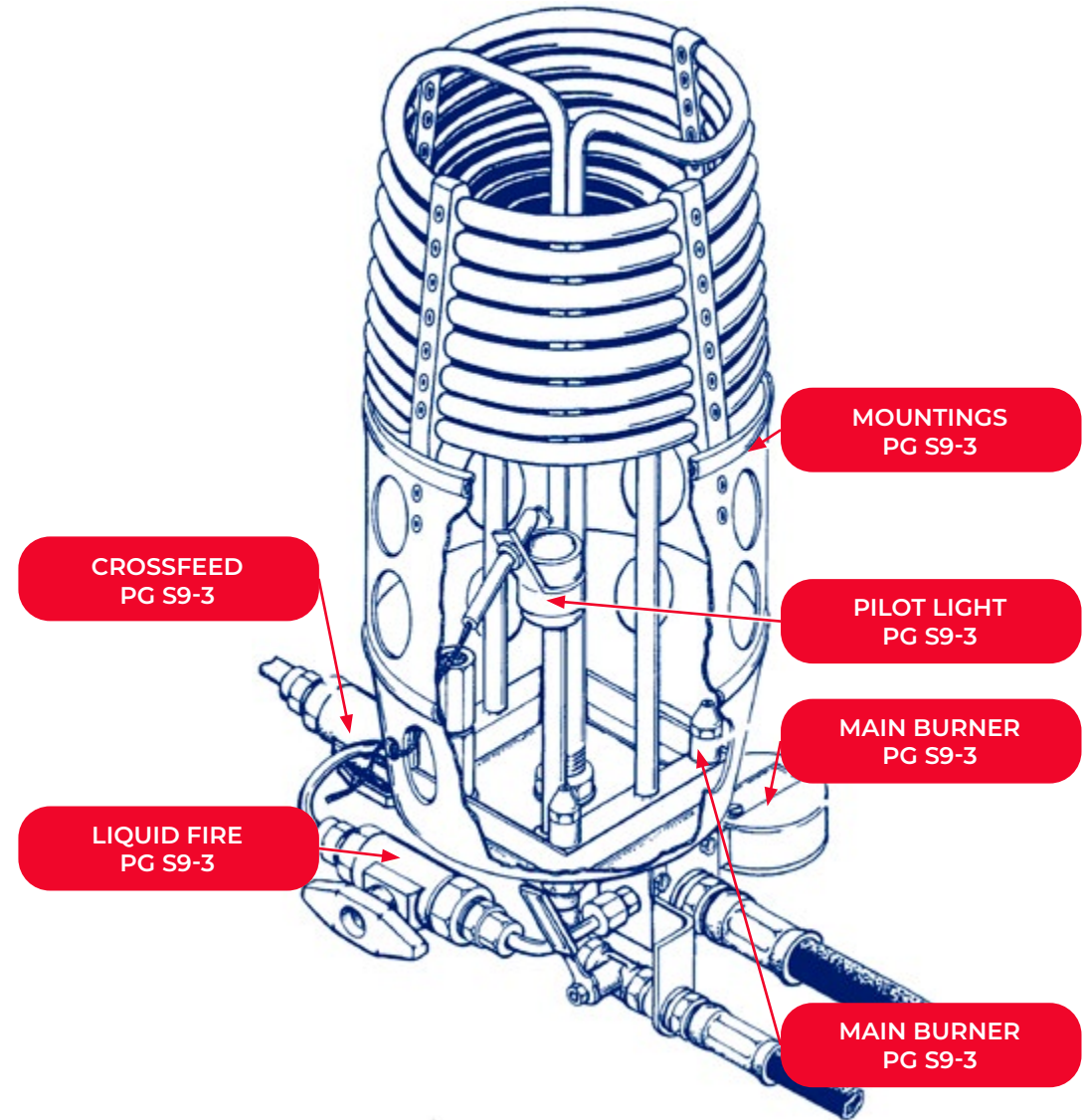

MAIN VALVE, CROSSFEED, COIL, JET & LIQUID FIRE ASSEMBLY

RIGHT HAND

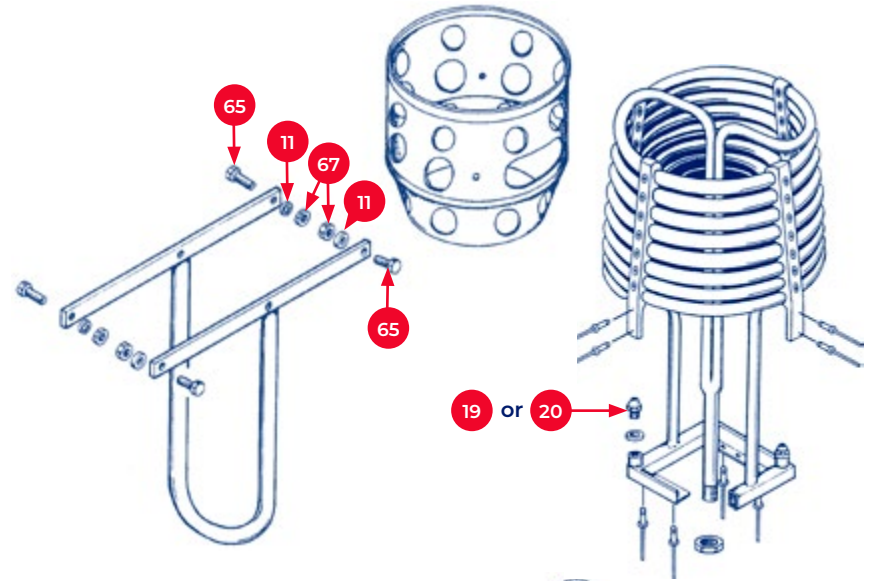
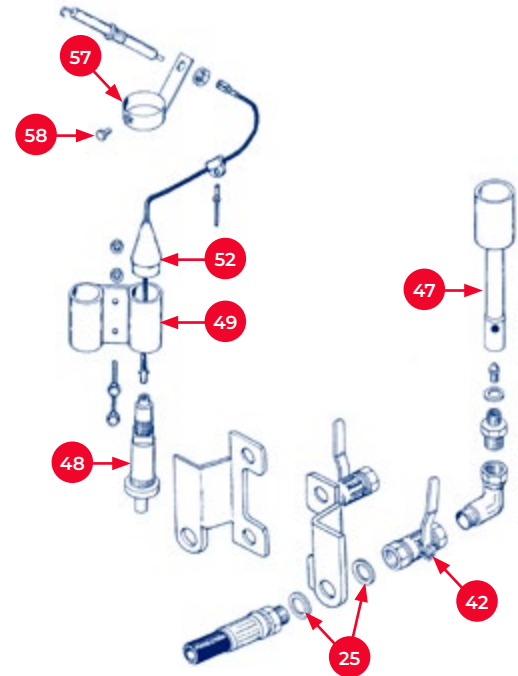
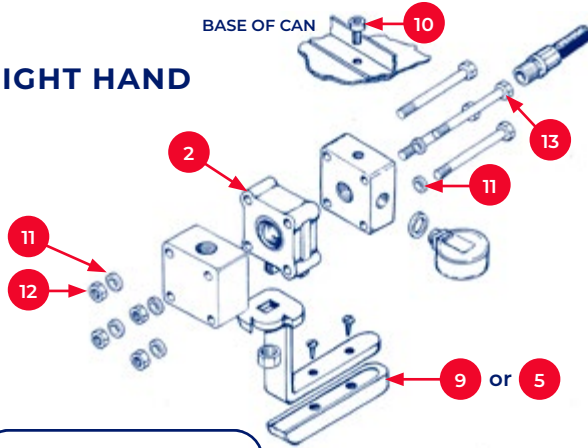

NOTES

WORCESTER VALVE SEAL KIT

21	CB-0392-0018
----	--------------

LEFT HAND

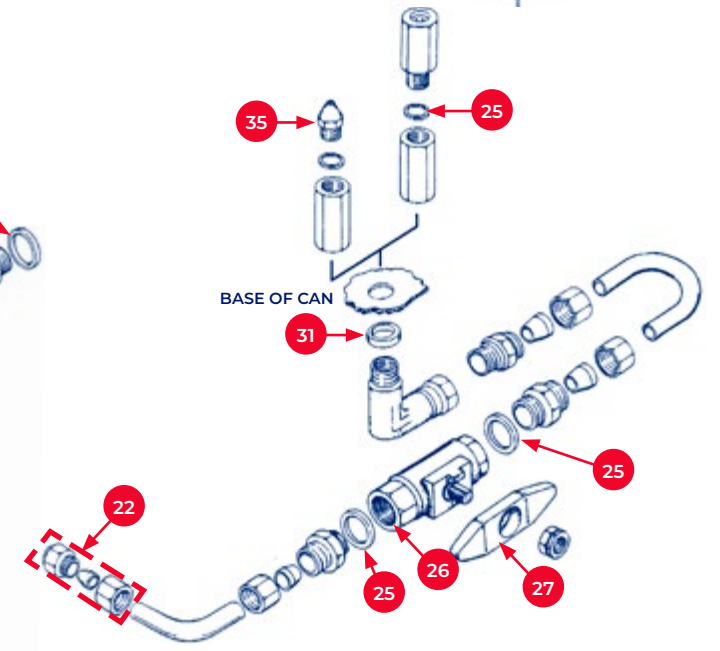
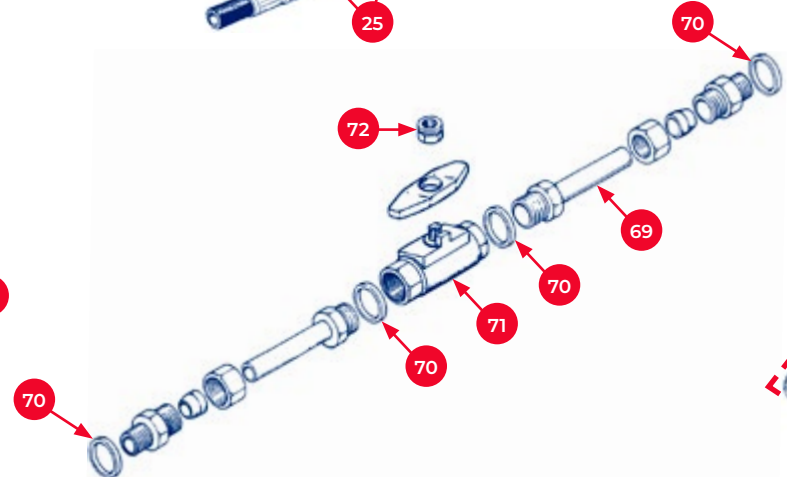
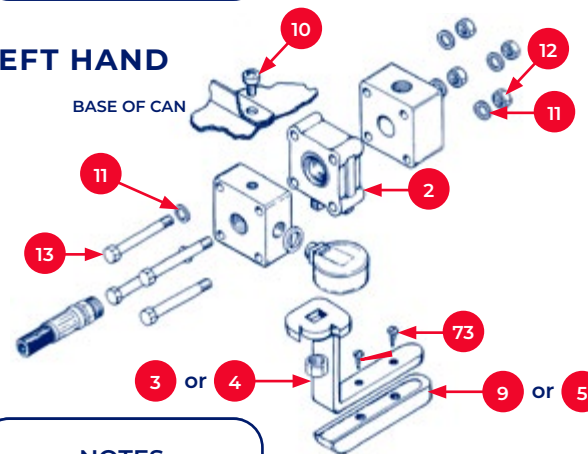

NOTES

WORCESTER VALVE SEAL KIT

21	CB-0392-0018
----	--------------

MAIN VALVE, CROSSFEED, COIL, JET & LIQUID FIRE ASSEMBLY

 <p>2 CB-0392-0017</p>	 <p>3 CA-0000-8145LH</p>	 <p>4 CA-0000-8145RH</p>	 <p>5 CA-0000-8146L</p>	 <p>9 CA-0000-8146D</p>	 <p>10 CY-0006-3010</p>	 <p>11 CY-0006-2008</p>	 <p>12 CY-0006-1002</p>	 <p>13 CY-0006-0090</p>
 <p>19 CA-0000-8014</p>	 <p>20 CA-0000-8345</p>	 <p>21 CB-0392-0018</p>	 <p>22 CA-0000-8165</p>	 <p>25 CA-0000-8201</p>	 <p>26 CA-0000-8049</p>	 <p>27 CA-0000-8140</p>	 <p>31 CA-0000-8064</p>	 <p>35 CA-0000-8136</p>
 <p>42 CA-0000-8017</p>	 <p>47 CA-0000-8023</p>	 <p>48 CA-0000-8105</p>	 <p>49 CA-0000-8020</p>	 <p>52 CA-0000-8052</p>	 <p>57 CA-0000-8031</p>	 <p>58 CY-0005-0010</p>	 <p>65 CY-0006-0025</p>	 <p>67 CY-0006-1004</p>
 <p>69 CA-0000-8044</p>	 <p>70 CA-0000-8198</p>	 <p>71 CA-0000-8147</p>	 <p>72 CA-0000-8141</p>	 <p>73 CA-0000-8184</p>				

Item	Description	Part #
2	COPPER WASHER	CB-0214-0006
3	WORCESTER BALL VALVE	CB-0392-0017
4	WORCESTER BALL VALVE HANDLE LEFTHAND	CA-0000-8145
5	WORCESTER BALL VALVE HANDLE RIGHTHAND	CA-0000-8145
6	WOOD HANDLE TRIM LIGHT	CA-0000-8146
10	M6 X 10 CAP HEAD BOLT	CY-0006-3010
11	M6 WASHER	CY-0006-2008
12	M6 NYLOC NUT	CY-0006-1002
14	WOOD HANDLE TRIM DARK	CA-0000-8146
19	TYPE 1520 MAIN JET	CA-0000-8014
20	MULTIHOLE MAIN JET (RETROFIT OPTION)	CA-0000-8345
21	WORCESTER VALVE SEAL KIT	CB-0392-0018
22	1/8 NPT X 8MM COMPRESSION FITTING	CA-0000-8165
24	1/4 BSP COPPER GASKET	CA-0000-8201
25	1/4 BSP DYNAQUIP BALL VALVE	CA-0000-8049
26	DYNAQUIP VALVE HANDLE (RED)	CA-0000-8140
30	1/4 BSP SPACER	CA-0000-8064
37	1/4 BSP KLINGER VALVE	CA-0000-8017
41	C2 PILOT FLAME TUBE	CA-0000-8023
42	PIEZO IGNITER	CA-0000-8105
43	CONE HOUSING	CA-0000-8052
47	ELECTRODE MOUNTING BRACKET	CA-0000-8031
49	M5 X 10 BOLT	CY-0005-0010
51	NO6 X 1/2" SCREW	CA-0000-8184

MAIN VALVE, LIQUID FIRE, COIL & PIEZO IGNITER ASSEMBLY

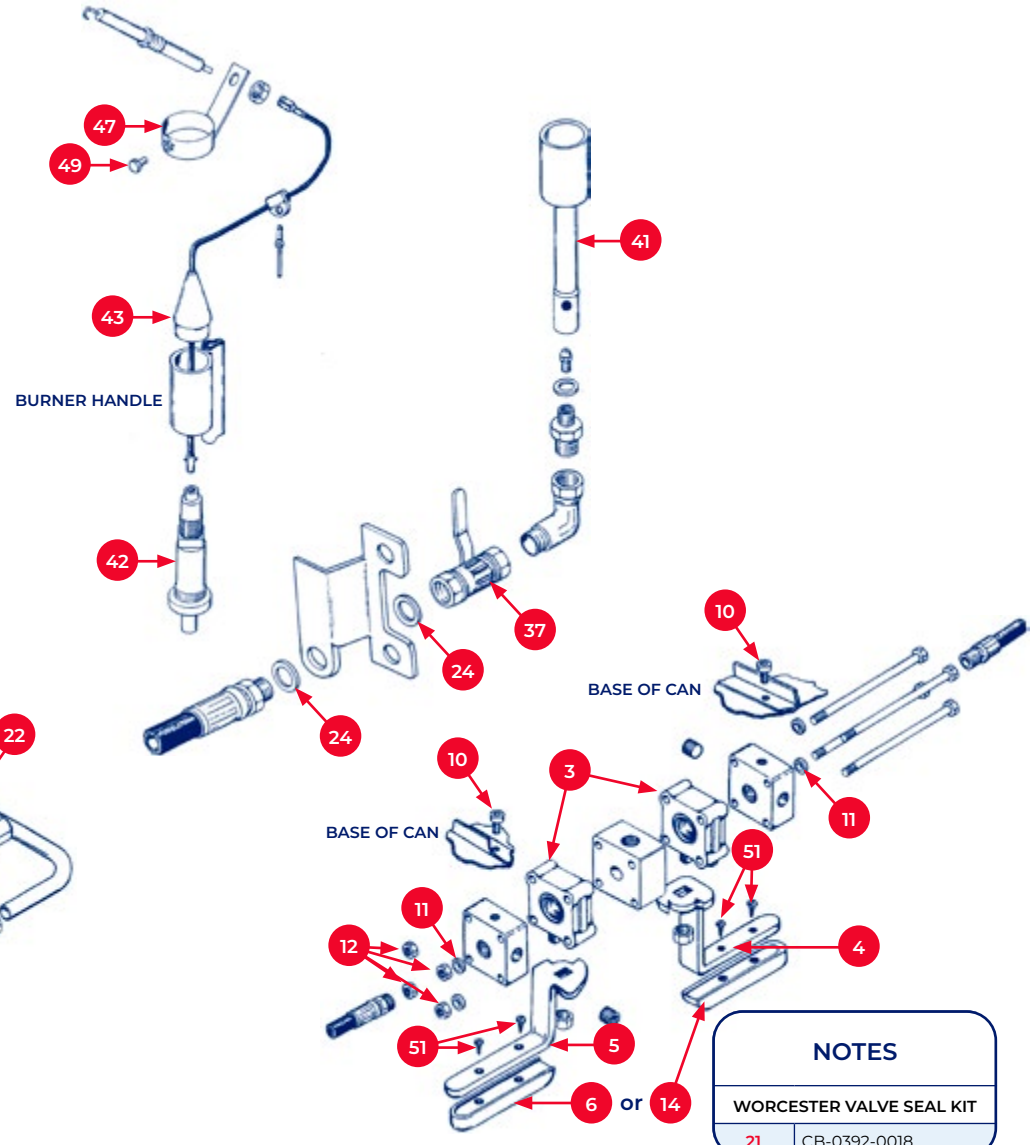
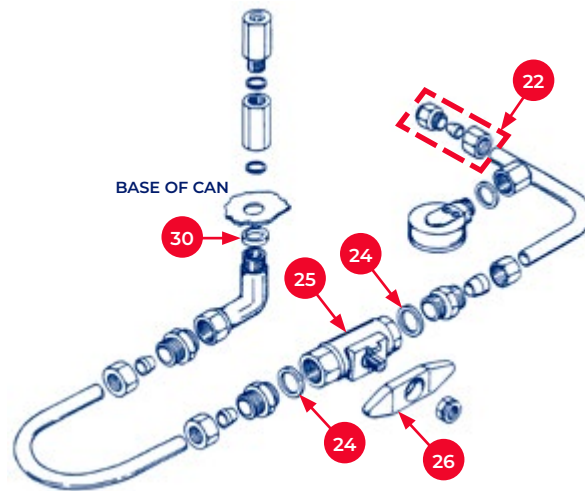
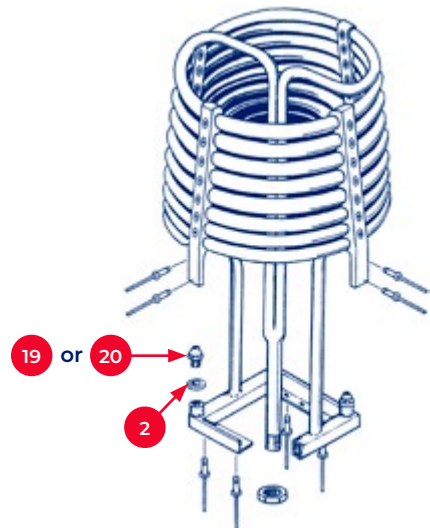

NOTES	
WORCESTER VALVE SEAL KIT	
21	CB-0392-0018

MAIN VALVE, LIQUID FIRE, COIL & PIEZO IGNITER ASSEMBLY

 <p>2</p> <p>CB-0214-0006</p>	 <p>3</p> <p>CB-0392-0017</p>	 <p>4</p> <p>CA-0000-8145 <i>LH</i></p>	 <p>5</p> <p>CA-0000-8145 <i>RH</i></p>	 <p>6</p> <p>CA-0000-8146L</p>	 <p>10</p> <p>CY-0006-3010</p>	 <p>11</p> <p>CY-0006-2008</p>	 <p>12</p> <p>CY-0006-1002</p>	 <p>14</p> <p>CA-0000-8146D</p>
 <p>19</p> <p>CA-0000-8014</p>	 <p>20</p> <p>CA-0000-8345</p>	 <p>21</p> <p>CB-0392-0018</p>	 <p>22</p> <p>CA-0000-8165</p>	 <p>24</p> <p>CA-0000-8201</p>	 <p>25</p> <p>CA-0000-8049</p>	 <p>26</p> <p>CA-0000-8140</p>	 <p>30</p> <p>CA-0000-8064</p>	 <p>37</p> <p>CA-0000-8017</p>
 <p>41</p> <p>CA-0000-8023</p>	 <p>42</p> <p>CA-0000-8105</p>	 <p>43</p> <p>CA-0000-8052</p>	 <p>47</p> <p>CA-0000-8031</p>	 <p>49</p> <p>CY-0005-0010</p>	 <p>51</p> <p>CA-0000-8184</p>			

Item	Description	Part #
3	3/8 BSP COPPER GASKET	CA-0000-8198
4	3/8 BSPM TO 3/8 BSPM ADAPTOR	CA-0001-0018
5	M6 X 90 BOLT	CY-0006-0090
6	M6 WASHER	CY-0006-2008
9	4BA X 3/8 PAN HEAD BOLT	CA-0000-8130
10	WORCESTER BALL VALVE HANDLE LEFTHAND	CA-0000-8145 LH
11	WORCESTER BALL VALVE HANDLE RIGHTHAND	CA-0000-8145 RH
13	WOOD HANDLE TRIM (LIGHT)	CA-0000-8146 L
14	WOOD HANDLE TRIM (DARK)	CA-0000-8146 D
15	WORCESTER BALL VALVE	CB-0392-0017
17	M6 X 10 SOCKET BOLT	CY-0006-3010
18	M6 AEROTIGHT NUT	CY-0006-1004
19	M6 X 16 BOLT	CY-0006-0016
20	1.3MM MAIN JET	CA-0000-8091
21	1.6MM MAIN JET	CA-0000-8011
22	WORCESTER VALVE SEAL KIT	CB-0392-0018
23	3/4 BSP COPPER GASKET	CA-0000-8201
25	3/4 BSP DYNAQUIP BALL VALVE	CA-0000-8049
26	DYNAQUIP VALVE HANDLE (RED)	CA-0000-8140
32	TYPE 3060 JET	CA-0000-8136
35	VAPORISER SPRING	CA-0000-8101

Item	Description	Part #
36	PISTON END SEAL	CB-8552-0000
37	MAGNUM VAPORISER SEAL KIT	CB-8635-0000
41	HOKE VALVE <i>NO REPAIR KIT IS AVAILABLE FOR THE HOKE VALVE</i>	CA-0000-8109
42	SINTERED FILTER (6MM DIAMETER)	CA-0000-8154
43	1/8 BSP TO 1/8 BSP ADAPTOR TAPPED 1BA	CA-0000-8090
44	LIQUID PILOT LIGHT JET	CB-8550-0000
45	PILOT FLAME TUBE	CA-0000-8112
46	PIEZO IGNITER	CA-0000-8105
47	IGNITER HOUSING	CA-0000-8106
48	C3 ELECTRODE	CA-0000-8290
49	1/8 NPTM X 1/8 COMPRESSION FITTING	CB-2472-0002
51	1/8 NPTF X 1/8 COMPRESSION FITTING	CB-8589-0000
55	PRESSURE GAUGE	CB-8590-0000
59	M6 X 25 BOLT	CY-0006-0025
60	M6 X 45 BOLT	CY-0006-0045
64	12MM X 60MM STANDPIPE	CA-0000-8044
65	3/8 BSP DYNAQUIP BALL VALVE	CA-0000-8147
66	DYNAQUIP VALVE HANDLE (GREEN)	CA-0000-8141
67	NO6 X 1/2" SCREW	CA-0000-8184

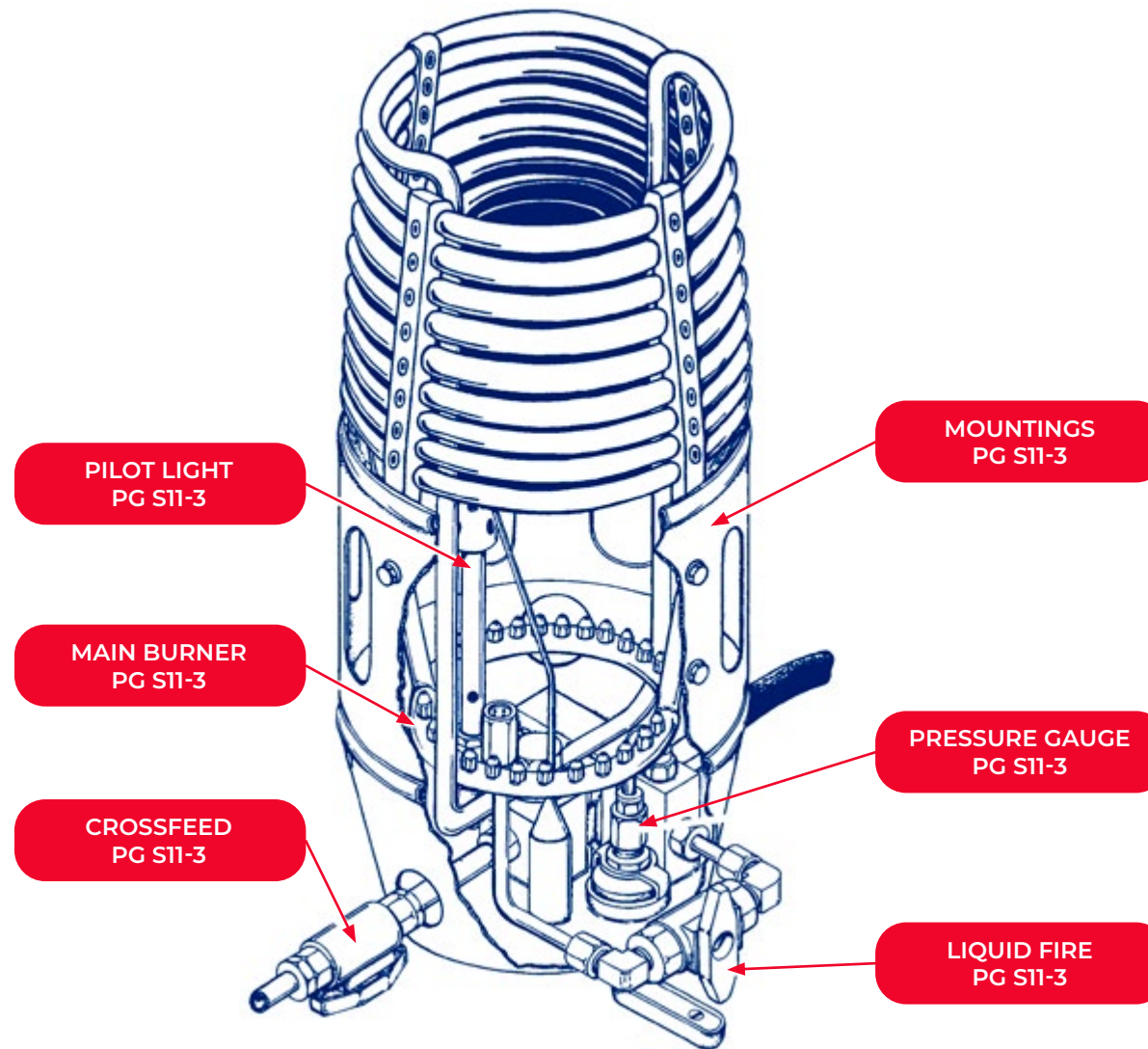

ENVELOPE COMPONENTS & ACCESSORIES

<p>3</p>  <p>CA-0000-8198</p>	<p>4</p>  <p>CA-0001-0018</p>	<p>5</p>  <p>CY-0006-0090</p>	<p>6</p>  <p>CY-0006-2008</p>	<p>9</p>  <p>CA-0000-8130</p>	<p>10</p>  <p>CA-0000-8145 LH</p>	<p>11</p>  <p>CA-0000-8145 RH</p>	<p>13</p>  <p>CA-0000-8146L</p>	<p>14</p>  <p>CA-0000-8146D</p>
<p>15</p>  <p>CB-0392-0017</p>	<p>17</p>  <p>CY-0006-3010</p>	<p>18</p>  <p>CY-0006-1004</p>	<p>19</p>  <p>CY-0006-0016</p>	<p>20</p>  <p>CA-0000-8091</p>	<p>21</p>  <p>CA-0000-8011</p>	<p>22</p>  <p>CB-0392-0018</p>	<p>23</p>  <p>CA-0000-8201</p>	<p>25</p>  <p>CA-0000-8049</p>
<p>26</p>  <p>CA-0000-8140</p>	<p>32</p>  <p>CA-0000-8136</p>	<p>35</p>  <p>CA-0000-8101</p>	<p>36</p>  <p>CB-8552-0000</p>	<p>37</p>  <p>CB-8635-0000</p>	<p>41</p>  <p>CA-0000-8109</p>	<p>42</p>  <p>CA-0000-8154</p>	<p>43</p>  <p>CA-0000-8090</p>	<p>44</p>  <p>CB-8550-0000</p>
<p>45</p>  <p>CA-0000-8112</p>	<p>46</p>  <p>CA-0000-8105</p>	<p>47</p>  <p>CA-0000-8106</p>	<p>48</p>  <p>CA-0000-8290</p>	<p>49</p>  <p>CB-2472-0002</p>	<p>51</p>  <p>CB-8589-0000</p>	<p>55</p>  <p>CB-8590-0000</p>	<p>59</p>  <p>CY-0006-0025</p>	<p>60</p>  <p>CY-0006-0045</p>
<p>64</p>  <p>CA-0000-8044</p>	<p>65</p>  <p>CA-0000-8147</p>	<p>66</p>  <p>CA-0000-8141</p>	<p>67</p>  <p>CA-0000-8184</p>					

Item	Description	Part #	Item	Description	Part #
5	VALVE SPRING	CU-7553-0009	43	VAPORISER SPRING	CA-0000-8101
6	VALVE STEM	CA-0000-8210	44	MAGNUM VAPORISER SEAL KIT	CB-8635-0000
7	M8 WASHER	CY-0008-2008	47	LIQUID PILOT LIGHT JET	CB-8550-0000
9	WEAR PAD	CA-0000-8227	49	PILOT FLAME TUBE	CA-0000-8112
12	4MM ROLL PIN	CA-0000-8220	51	VENT TUBE	CA-0000-8233
13	TOGGLE / PIVOT PIN	CA-0000-8299	53	O-RING (STOP PLATE WATER SEAL) (I.D. 30 X Ø1.5) (DOWTY NO 206-030)	CA-0000-8296
14	TOGGLE / PIVOT PIN CIRCLIP (5MM)	CA-0000-8300	56	PILOT LIGHT VALVE STEM (PRE MOD T157)	CA-0000-8317
16	M5 X 45 CAP HEAD BOLT	CY-0005-3045	60	PILOT VALVE HANDLE (YELLOW)	CA-0000-8232
17	LIGHT WOOD HANDLE LEFTHAND	CA-0000-8222	61	M5 X 13 CSK HEAD BOLT	CY-0005-5013
18	SLURPER TUBE LEFTHAND	CA-0000-8193 LH	63	PIEZO IGNITER	CA-0000-8105
19	SLURPER TUBE RIGHTHAND	CA-0000-8193 RH	64	IGNITER HOUSING (PRE MOD T157)	CA-0000-8106
20	3/8 BSP COPPER GASKET	CA-0000-8198	65	C3 ELECTRODE (PRE MOD T157)	CA-0000-8290
21	M6 AEROTIGHT NUT	CY-0006-1004	66	IGNITER INSULATOR	CA-0000-8310
22	M6 WASHER	CY-0006-2008	67	M22 THIN NUT	CA-0000-8307
23	M6 X 16 BOLT	CY-0006-0016	68	NYLON WASHER	CA-0000-8306
24	1.3MM MAIN JET	CA-0000-8091	71	CERAMIC TUBE	CA-0000-8282
25	1.6MM MAIN JET	CA-0000-8011	73	1/8 NPTM X 1/8 COMPRESSION FITTING	CB-2472-0002
27	BANJO BOLT	CA-0000-8196	75	1/8 NPTF X 1/8 COMPRESSION FITTING	CB-8589-0000
28	COPPER GASKET	CA-0000-8245	77	PRESSURE GAUGE BRACKET	CA-0000-8238
29	MAGNUM MAIN VALVE SEAL KIT	CB-8634-0000	79	PRESSURE GAUGE	CB-8590-0000
30	¼ BSP COPPER GASKET	CA-0000-8201	83	M6 X 25 BOLT	CY-0006-0025
31	¼ BSP THREADED INSERT	CA-0000-8241	86	M6 X 45 BOLT	CY-0006-0045
33	ALUMINIUM STOP TUBE	CA-0000-8244	90	12MM X 60MM STANDPIPE	CA-0000-8044
34	DYNAQUIP VALVE HANDLE (RED)	CA-0000-8140	92	3/8 BSP DYNAQUIP BALL VALVE	CA-0000-8147
36	LEGRIS BALL VALVE SEAL KIT	DISCONTINUED	93	DYNAQUIP VALVE HANDLE (GREEN)	CA-0000-8141
42	PISTON END SEAL	CB-8552-0000	94	LARGE SINTERED FILTER	CA-0000-8102

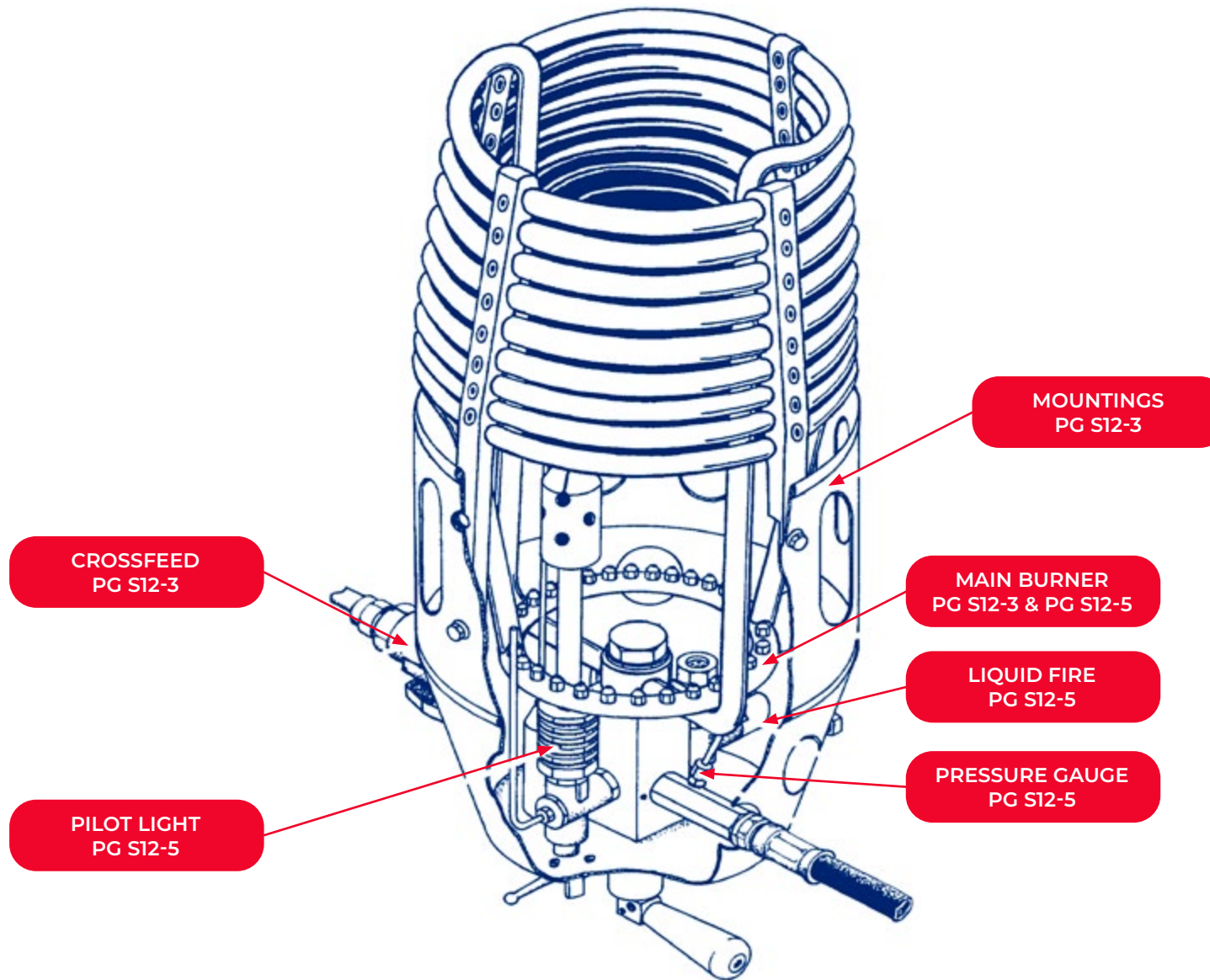

TOGGLE VALVE, COILS, HANDLE, CROSSFEED AND JET ASSEMBLY

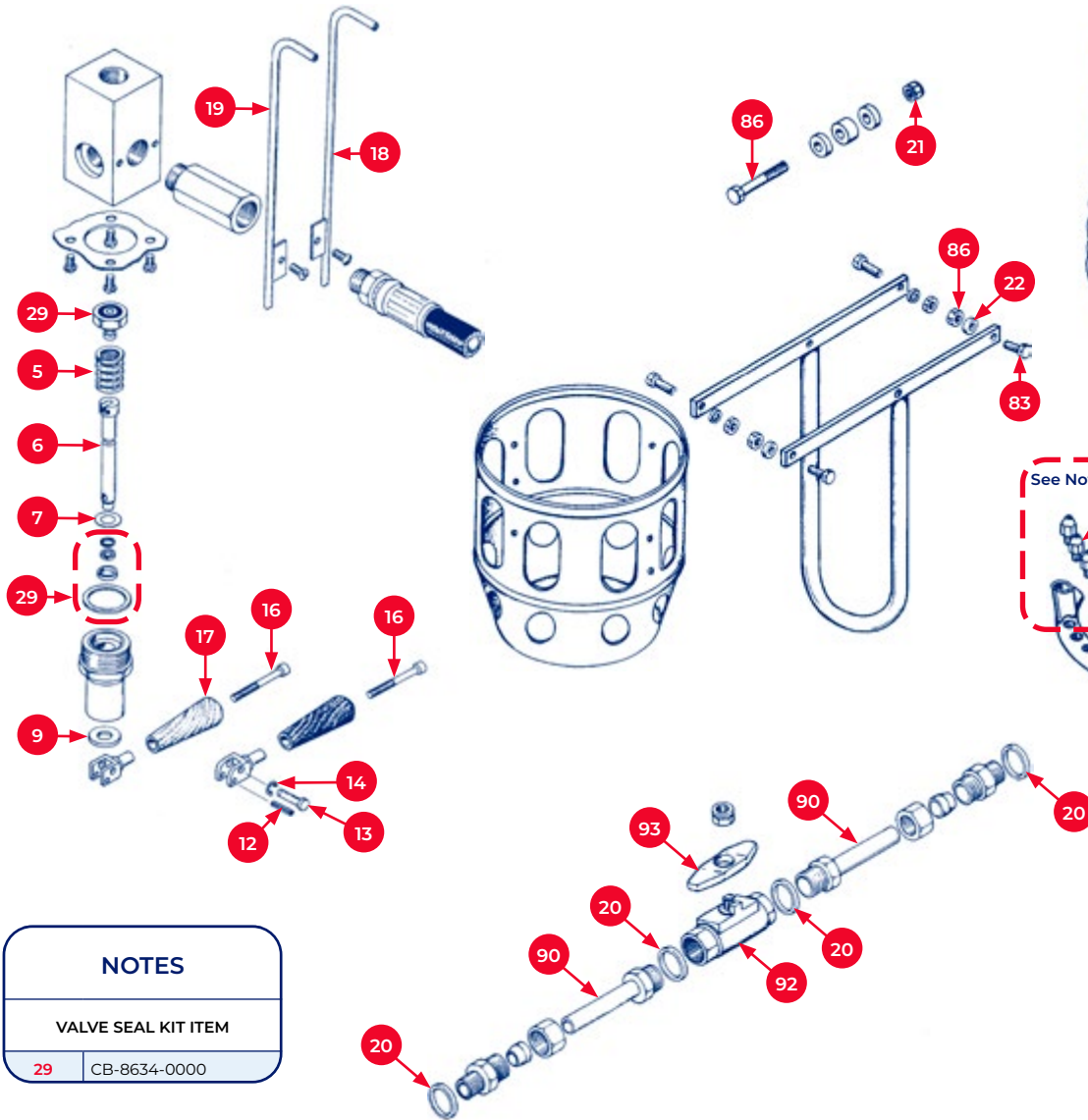

NOTES	
VALVE SEAL KIT ITEM	
29	CB-8634-0000

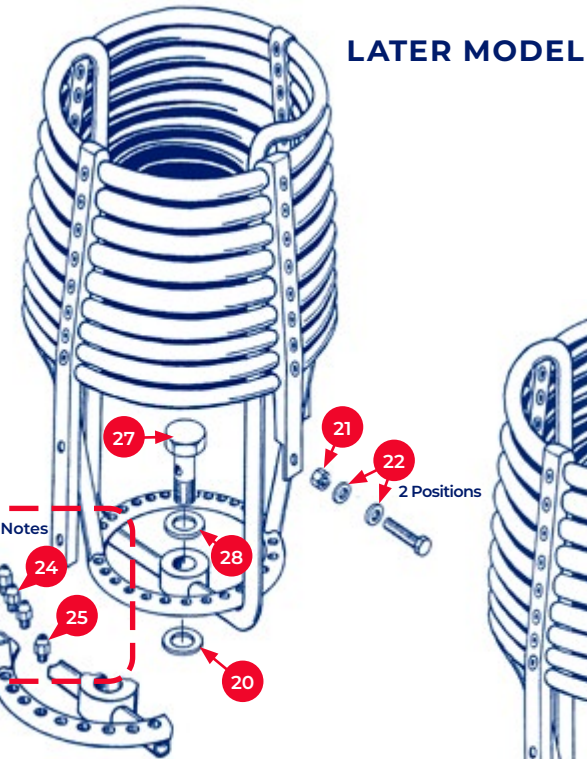

LATER MODEL

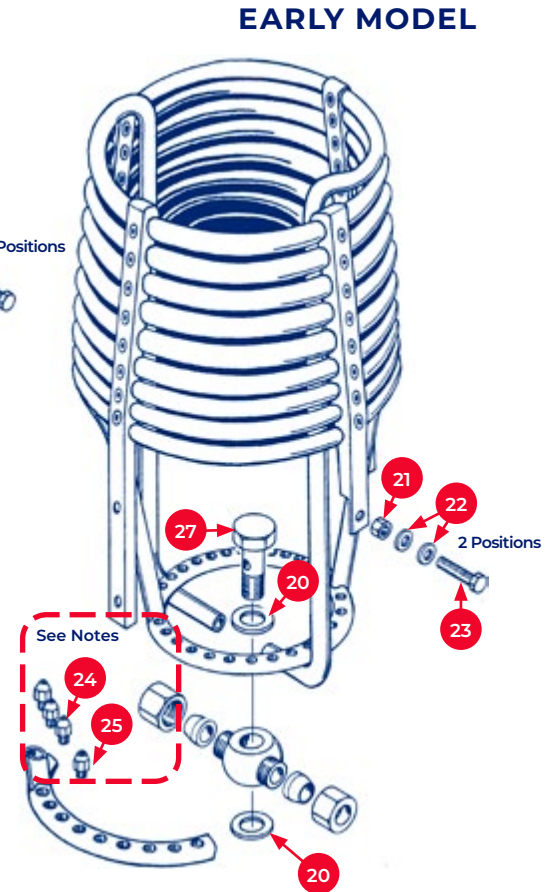

EARLY MODEL

NOTES	
VALVE SEAL KIT ITEM	
29	CB-8634-0000 28 Jets Per Coil
LATER MODELS & RETROFIT	
24	CA-0000-8091 21 Jets Per Coil
25	CA-0000-8011 7 Per Coil, every 4 th Jet



TOGGLE VALVE, COILS, HANDLE, CROSSFEED AND JET ASSEMBLY

<p>5</p>  <p>CU-7553-0009</p>	<p>6</p>  <p>CA-0000-8210</p>	<p>7</p>  <p>CY-0008-2008</p>	<p>9</p>  <p>CA-0000-8227</p>	<p>12</p>  <p>CA-0000-8220</p>	<p>13</p>  <p>CA-0000-8299</p>	<p>14</p>  <p>CA-0000-8300</p>	<p>16</p>  <p>CY-0005-3045</p>	<p>17</p>  <p>CA-0000-8222</p>
<p>18</p>  <p>CA-0000-8193L LEFTHAND</p>	<p>19</p>  <p>CA-0000-8193R RIGHTHAND</p>	<p>20</p>  <p>CA-0000-8198</p>	<p>21</p>  <p>CY-0006-1004</p>	<p>22</p>  <p>CY-0006-2008</p>	<p>23</p>  <p>CY-0006-0016</p>	<p>24</p>  <p>CA-0000-8091</p>	<p>25</p>  <p>CA-0000-8011</p>	<p>27</p>  <p>CA-0000-8196</p>
<p>28</p>  <p>CA-0000-8245</p>	<p>29</p>  <p>CB-8634-0000</p>	<p>83</p>  <p>CY-0006-0025</p>	<p>86</p>  <p>CY-0006-0045</p>	<p>90</p>  <p>CA-0000-8044</p>	<p>92</p>  <p>CA-0000-8147</p>	<p>93</p>  <p>CA-0000-8141</p>		

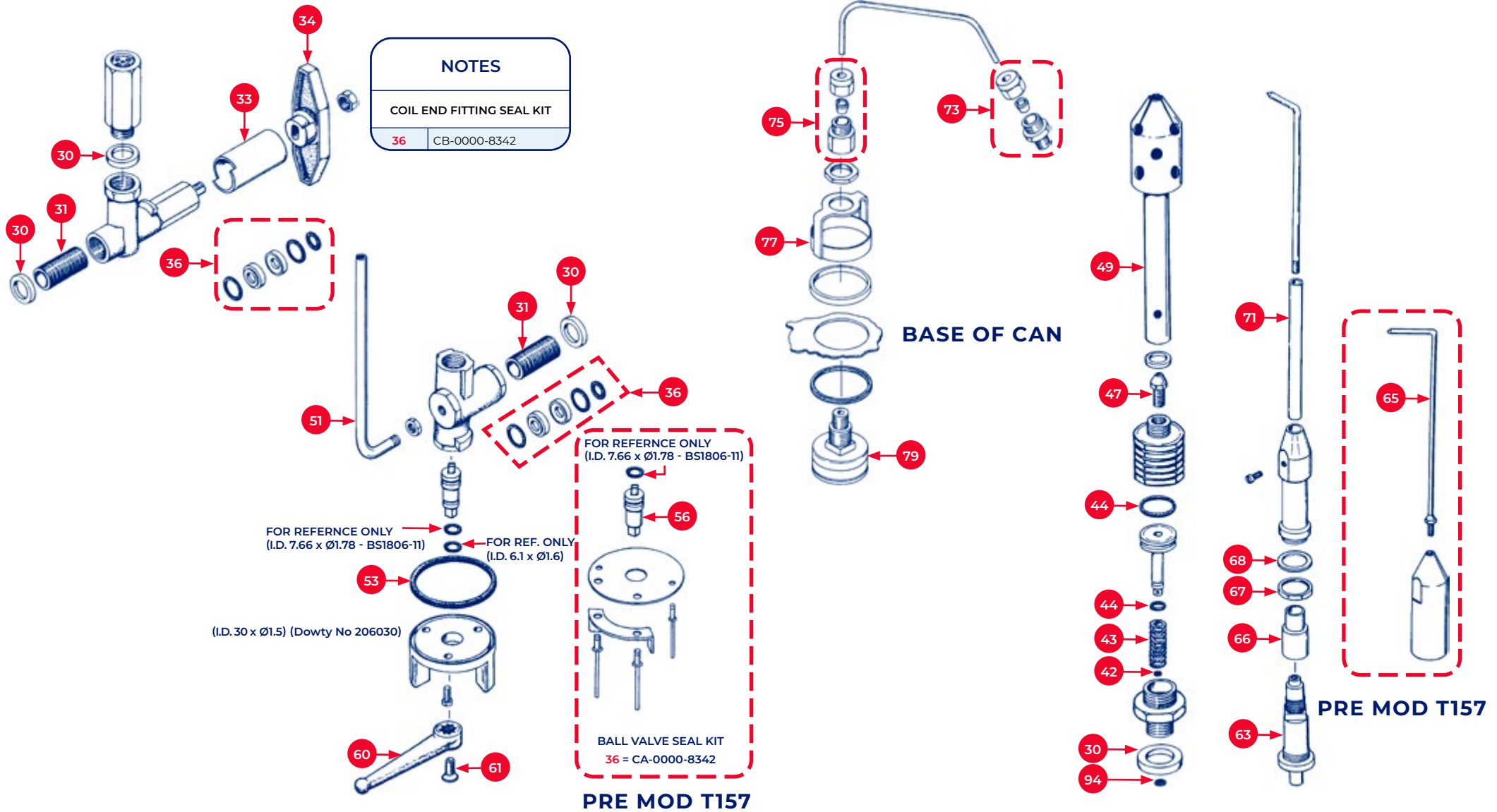
LIQUID FIRE, PILOT LIGHT VALVE, PILOT LIGHT & PIEZO ASSEMBLY



LIQUID FIRE, PILOT LIGHT VALVE, PILOT LIGHT & PIEZO ASSEMBLY

 <p>30 CA-0000-8201</p>	 <p>31 CA-0000-8241</p>	 <p>33 CA-0000-8244</p>	 <p>34 CA-0000-8140</p>	 <p>36 DISCONTINUED</p>	 <p>42 CB-8552-0000</p>	 <p>43 CA-0000-8101</p>	 <p>44 CB-8635-0000</p>	 <p>47 CB-8550-0000</p>
 <p>49 CA-0000-8112</p>	 <p>51 CA-0000-8233</p>	 <p>53 CA-0000-8296</p>	 <p>56 CA-0000-8317 <i>PRE MOD T157</i></p>	 <p>60 CA-0000-8232</p>	 <p>61 CY-0005-5013</p>	 <p>63 CA-0000-8105</p>	 <p>64 CA-0000-8106 <i>PRE MOD T157</i></p>	 <p>65 CA-0000-8290 <i>PRE MOD T157</i></p>
 <p>66 CA-0000-8310</p>	 <p>67 CA-0000-8307</p>	 <p>68 CA-0000-8306</p>	 <p>71 CA-0000-8282</p>	 <p>73 CB-2472-0002</p>	 <p>75 CB-8589-0000</p>	 <p>77 CA-0000-8238</p>	 <p>79 CB-8590-0000</p>	 <p>94 CA-0000-8102</p>

Item	Description	Part #
1	COPPER WASHER	BU2298
2	SEAT & CARRIER	BU8018
3	SEAT CARRIER SLEEVE	CQ2039 (WAS BU2046)
4	VALVE SPRING	BU2045
5	VALVE STEM - LONG	CQ2041
6	VALVE SEAL QUAD RING	BU2222
7	THIN WASHER	BU2001
8	STEM SEAL	BU2223
9	LONG VALVE BONNET (ONLY AVAILABLE IN SILVER)	BU2043
10	THRUST WASHER	BU8050
	<i>PLEASE SPECIFY: A = 2.5MM, B = 2.8MM, C = 3.0MM, D = 3.2MM, E = 3.5MM OR F = 2.0MM</i>	
11	VALVE HANDLE PIVOT	BU2040
12	M4 GRUB SCREW	BU2114
13	MAIN BURNER VALVE HANDLE	BU2049
14	VALVE STEM - SHORT	CQ2040
15	SHORT VALVE BONNET (ONLY AVAILABLE IN SILVER)	BU2051
16	LIQUID FIRE VALVE HANDLE	BU2029
17	REGULATOR FILTER	BU2022
18	REGULATOR SMALL O-RING	BU2229
19	SPRING CAP	BU2059
20	REGULATOR SPRING	BU2057
21	SPRING GUIDE	BU2058
22	VITON VALVE BALL	BU2232
23	REGULATOR LARGE O-RING	BU2230
24	REGULATOR BODY	BU2055
25	PUSHROD	BU2056
26	BRASS SLOT SCREW	BU2231
27	PISTON CAP	BU2060
28	PISTON SEAL	BU2228
29	PISTON	BU2062
30	MAIN REGULATOR SPRING	BU2061
31	SPRING RETAINER	BU2054
32	KNOB SPRING	BU2063
33	REGULATOR KNOB	BU2052
34	REGULATOR CIRCLIP	BU2247
35	REGULATOR KNOB SCREW	BU2053
36	¼" BSP COPPER WASHER	BU2084
37	LIQUID FIRE ADAPTOR	BU2064
38	LIQUID FIRE BODY	BU2067
39	PRESSURE GAUGE BEZEL	BU8088
40	PRESSURE GAUGE (IMPORTANT - NEW GAUGE WILL REQUIRE ITEM 39)	BU8079
41	GAUGE FACE SEAL	BU2218
42	GAUGE SMALL SEAL	CU-7553-0012 (WAS BU2217)
43	SHIM / SUPPORT WASHER	BU2234

REGULATOR ASSEMBLY - MKI & MKII

BU2021

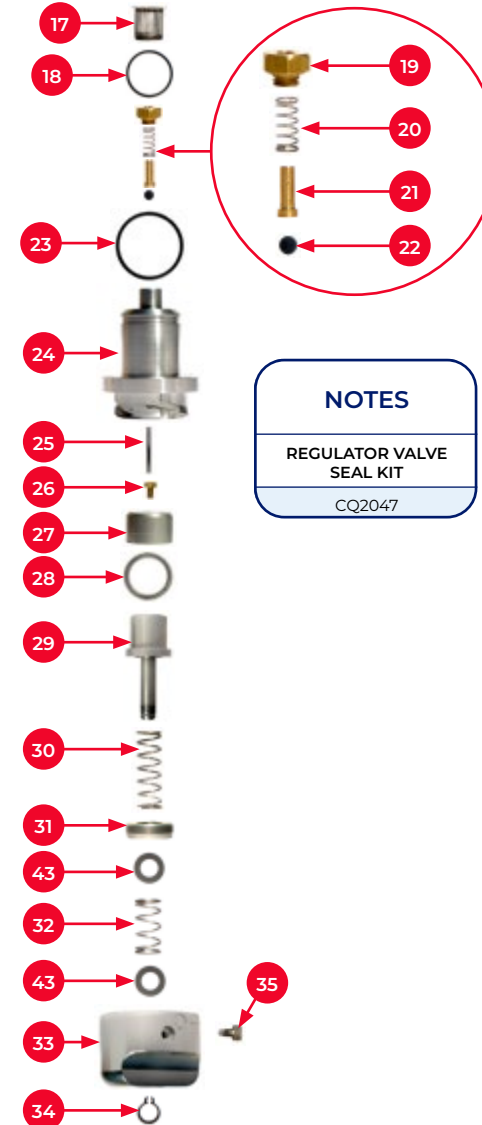

VALVE ASSEMBLY - MKI & MKII

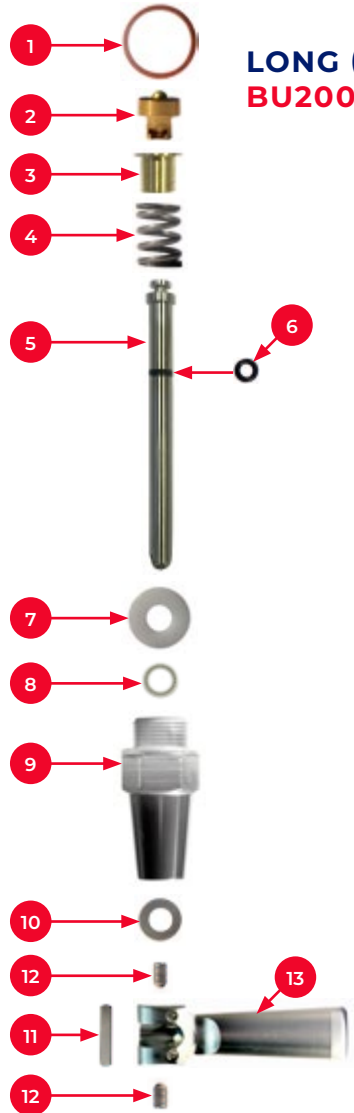

LONG (MAIN BURNER)
BU2007

NOTES	
REGULATOR VALVE SEAL KIT	
CQ2047	
REMOTE VALVE SEAL KIT	
CQ2050	

TO COMPLETE SERVICE BULLETIN 23	
LONG SPINDLE MOD KIT CQ2043	
CONTAINS	
5	CQ2041
1	BU2298
6	BU2222 - Already Installed onto Item
3	CQ-2039
8	BU2223
EXTRA SHORT SPINDLE MOD KIT CQ2043	
CONTACT CBL - CQ-2042	
REMOTE VALVE MOD KIT FOR REMOTE BURNERS ONLY	
CONTACT CBL - CQ-2044	

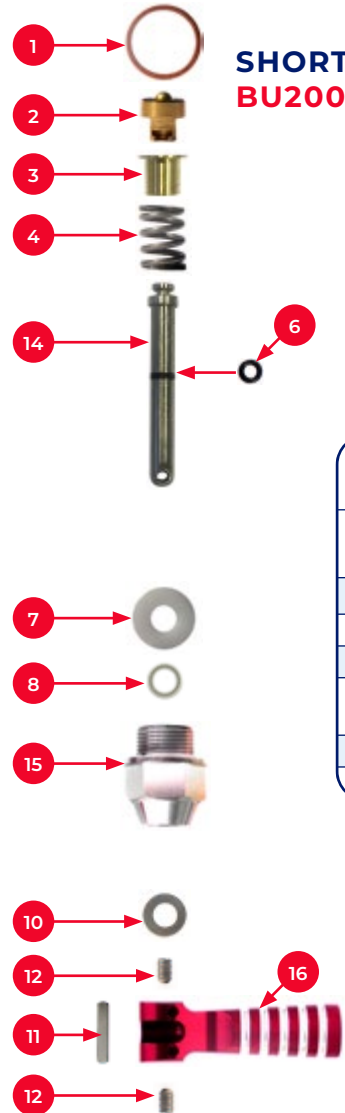

SHORT (LIQUID FIRE)
BU2008

TO COMPLETE SERVICE BULLETIN 23	
SHORT SPINDLE MOD KIT BU2008	
CONTAINS	
14	CQ2040
1	BU2298
6	BU2222 - Already Installed onto Item
3	CQ-2039
8	BU2223

LIQUID JET ASSEMBLY - MKI & MKII

BU2009

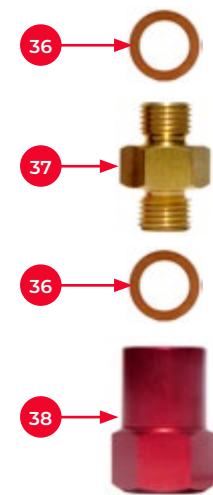

PRESSURE GAUGE ASSEMBLY MKI & MKII - BU8023

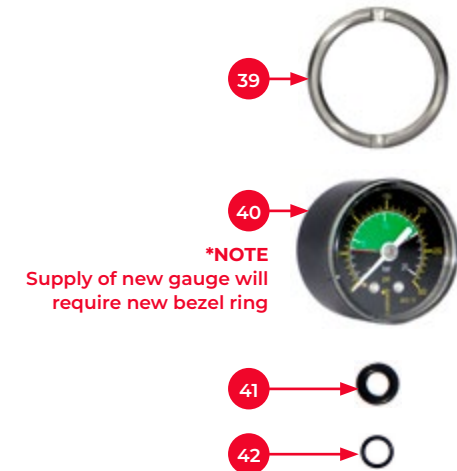

Item	Description	Part #
1	PIEZO KIT	CQ2118
2	IGNITER COMPLETE ASSEMBLY	CQ2119
4	CERAMIC TUBE & CIRCLIP	BU2080
5	IGNITER BODY	BU2089
6	O-RING SEAL	BU2242
7	PILOT LIGHT CUP, RIGHT HAND	BU2076
8	PILOT LIGHT CUP, LEFT HAND	BU2087
9	PILOT LIGHT STEM	BU2069
10	PILOT LIGHT JET - 0.40	BU2037
11	COPPER WASHER	BU2205
12	PILOT LIGHT ADAPTOR	BU2068
13	PILOT LIGHT FILTER	BU2250
14	¼" BSP COPPER WASHER	BU2084
15	TRIGGER GRIP	BU8048
16	BLAST TRIGGER WELDED ASSEMBLY	BU8010
17	PIVOT PIN	BU8045
18	4MM STANDARD EXTERNAL CIRCLIP	BU2094
19	STAINLESS STEEL COMPRESSION SPRING	BU2990
20	STAINLESS STEEL SPRING CAP	BU8074
21	HANDLE TUBE	BU8046
22	M3 X 8 HEX DRIVE CSK STAINLESS STEEL SCREW	BU2978
23	UPPER VALVE POST	BU8042
24	LOWER VALVE POST	BU8043
25	BEZEL RING DRIVER	CQ2118-0004

(USED TO INSTALL BEZEL RING FOR IGNITER ASSEMBLY) ONLY COMPATIBLE WITH JETSTREAM

IGNITER ASSEMBLY - MKI & MKII BU8024

BEZEL RING DRIVER

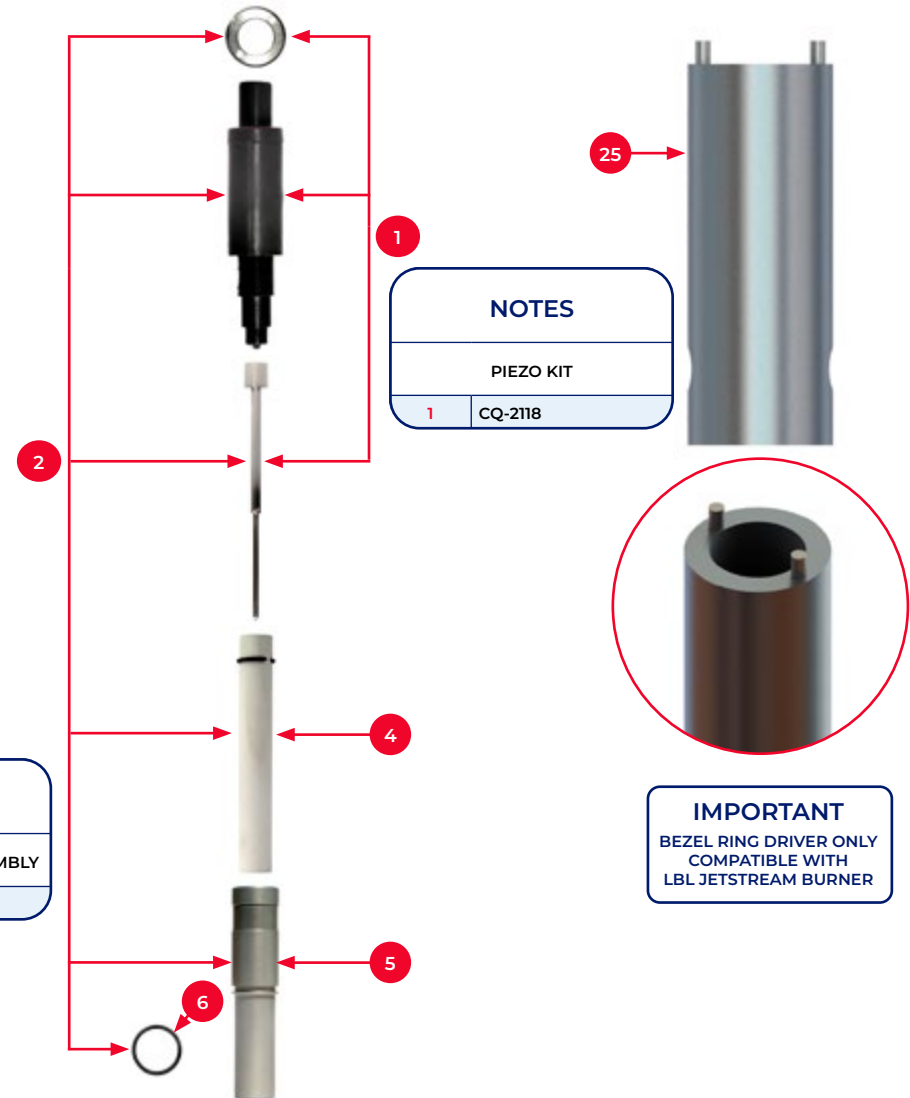

NOTES

IGNITER COMPLETE ASSEMBLY	
2	CQ-2119

NOTES

PIEZO KIT	
1	CQ-2118

IMPORTANT
BEZEL RING DRIVER ONLY
COMPATIBLE WITH
LBL JETSTREAM BURNER

PILOT LIGHT ASSEMBLY - MKI & MKII BU2010

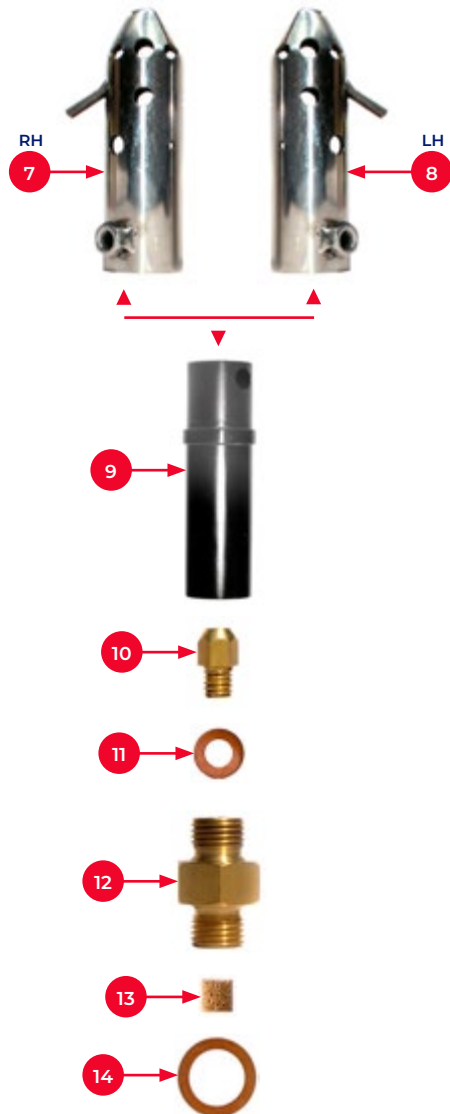

SQUEEZE ASSEMBLY - MKII ONLY

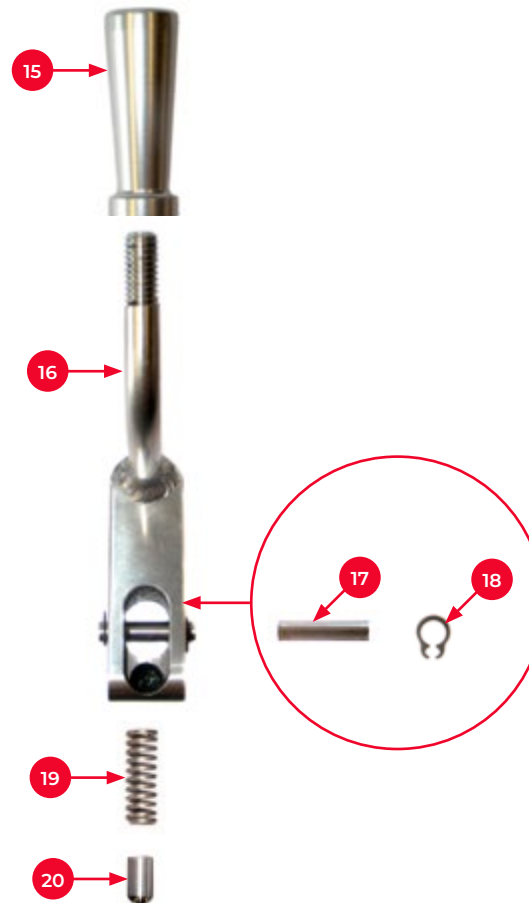

HANDLE - MKII ONLY



Item	Description	Part #
SHADOW, STEALTH, SIROCCO, MK4 SUPER LIQUID HOSE ASSY (3/8 NOMINAL BORE)		
HOSES WITH SWAGED END FITTINGS, REGO, (NO COUPLINGS)		
1	Ø3/8, ¼NPT - ¼NPT, 2.6M (DOUBLE)	CB-7626-1100
2	Ø3/8, ¼NPT - ¼NPT, 4.0M (TRIPLE/QUAD)	CB-7640-1100
HOSES WITH SWAGED END FITTINGS, TEMA, OR HI-FLOW (NO COUPLINGS)		
3	Ø3/8, ¼NPT - 3/8BSP (G3/8), 2.6M (DOUBLE)	CB-7626-1400
4	Ø3/8, ¼NPT - 3/8BSP (G3/8), 4.0M (TRIPLE/QUAD)	CB-7640-1400
HOSES, COMPLETE WITH ONE REGO COUPLING		
5	Ø3/8, ¼NPT - ¼NPT, 2.6M, REGO COUPLING (DOUBLE)	CB-7626-1110
6	Ø3/8, ¼NPT - ¼NPT, 4.0M, REGO COUPLING (TRIPLE / QUAD)	CB-7640-1110
HOSES, COMPLETE WITH ONE TEMA COUPLING		
7	Ø3/8, ¼NPT - 3/8BSP (G3/8), 2.6M, TEMA (DOUBLE)	CB-7626-1420
8	Ø3/8, ¼NPT - 3/8BSP (G3/8), 4.0M, TEMA (TRIPLE/QUAD)	CB-7640-1420
HOSES, COMPLETE WITH ONE HI-FLOW COUPLING		
178	Ø3/8, ¼NPT - 3/8BSP (G3/8), 2.6M, HI-FLOW (DOUBLE)	CB-7626-1450
179	Ø3/8, ¼NPT - 3/8BSP (G3/8), 4.0M, HI-FLOW (TRIPLE/QUAD)	CB-7640-1450
STRATUS NEO, STRATUS, MAGNUM (C3T), C3 (MKIII), C2 (MKII) LIQUID HOSE ASSY (3/8 NOMINAL BORE)		
HOSES WITH SWAGED END FITTINGS, REGO, (NO COUPLINGS)		
3	Ø3/8, ¼NPT - 3/8BSP (G3/8), 2.6M (DOUBLE)	CB-7626-1400
4	Ø3/8, ¼NPT - 3/8BSP (G3/8), 4.0M (TRIPLE/QUAD)	CB-7640-1400
HOSES WITH SWAGED END FITTINGS, TEMA, OR HI-FLOW (NO COUPLINGS)		
9	Ø3/8, 3/8BSP - 3/8BSP (G3/8), 2.6M (DOUBLE)	CB-7626-4400
10	Ø3/8, 3/8BSP - 3/8BSP (G3/8), 4.0M (TRIPLE/QUAD)	CB-7640-4400
HOSES, COMPLETE WITH ONE REGO COUPLING		
11	Ø3/8, ¼NPT - 3/8BSP, 2.6M, REGO COUPLING (DOUBLE)	CB-7626-1410
12	Ø3/8, ¼NPT - 3/8BSP, 4.0M, REGO COUPLING (TRIPLE/QUAD)	CB-7640-1410
HOSES, COMPLETE WITH ONE TEMA COUPLING		
13	Ø3/8, 3/8BSP - 3/8BSP, 2.6M, TEMA COUPLING (DOUBLE)	CB-7626-4420
14	Ø3/8, 3/8BSP - 3/8BSP, 4.0M, TEMA COUPLING (TRIPLE/QUAD)	CB-7640-4420
HOSES, COMPLETE WITH ONE HI-FLOW COUPLING		
180	Ø3/8, 3/8BSP - 3/8BSP, 2.6M, HI-FLOW COUPLING (DOUBLE)	CB-7626-4450
181	Ø3/8, 3/8BSP - 3/8BSP, 4.0M, HI-FLOW COUPLING (TRIPLE/QUAD)	CB-7640-4450

*IMPORTANT

Items 15 & 16 Must be used on Triple & Quad Burners when fitted with crossfeed

Item	Description	Part #
STRATUS NEO, SAFIRE, STRATUS, TRIPLE/QUAD, CROSSFLOW LIQUID HOSE ASSY, TEMA OR HI-FLOW ONLY (½ NOMINAL BORE)		
HOSES WITH SWAGED END FITTINGS (NO COUPLINGS)		
*15	Ø3/8, 3/8BSP - 3/8BSP (G3/8), 4.0M (TRIPLE/QUAD)	CB-7640-4400
*15	Ø1/2, 3/8BSP - 3/8BSP (G3/8), 4.0M (TRIPLE/QUAD)	CB-7840-4400
HOSES, COMPLETE WITH ONE TEMA COUPLING		
*16	Ø1/2, 3/8BSP - 3/8BSP, 4.0M, TEMA COUPLING (TRIPLE/QUAD)	CB-7840-4420
HOSES, COMPLETE WITH ONE HI-FLOW COUPLING		
182	Ø1/2, 3/8BSP - 3/8BSP, 4.0M, HI-FLOW COUPLING (TRIPLE/QUAD)	CB-7840-4450
SHADOW, STEALTH, MK4 SUPER VAPOUR HOSE ASSY (¼ NOMINAL BORE)		
17	Ø¼, ¼NPT - DYNAQUIP MALE, 1.8M (DOUBLE)	CB-7418-1800
18	Ø¼, ¼NPT - DYNAQUIP MALE, **M (TRIPLE/QUAD)	CB-74**-1800
19	Ø¼, ¼NPT - TEMA MALE, 1.8M (DOUBLE)	CB-7418-1700
20	Ø¼, ¼NPT - TEMA MALE, **M (TRIPLE/QUAD)	CB-74**-1700
**M = PLEASE SPECIFY HOSE LENGTH REQUIRED		
MAGNUM (C3T), C3 (MKIII), C2 (MKII) VAPOUR HOSE ASSY (¼ NOMINAL BORE)		
21	Ø¼, ¼BSP - DYNAQUIP MALE, 1.8M (DOUBLE)	CB-7418-2800
22	Ø¼, ¼BSP - DYNAQUIP MALE, **M (TRIPLE/QUAD)	CB-74**-2800
23	Ø¼, ¼BSP - TEMA MALE, 1.8M (DOUBLE)	CB-7418-2700
24	Ø¼, ¼BSP - TEMA MALE, 1.8M (TRIPLE/QUAD)	CB-74**-2700
**M = PLEASE SPECIFY HOSE LENGTH REQUIRED		
6LB VAPOUR CYLINDER		
168	Ø¼, ¼NPT - DYNAQUIP MALE, 0.6M	CB-7406-1800
169	Ø¼, ¼NPT - TEMA MALE, 0.6M	CB-7406-2700
MANIFOLD SYSTEMS		
25	MANIFOLD - 2 CYL - 1 X REGO MALE TO 2 X REGO FEMALE	CB-0440-1000
26	MANIFOLD - 2 CYL - REGO - ALTERNATIVE ASSEMBLY	CB-0440-5000
27	MANIFOLD - 2 CYL - 1 X TEMA MALE TO 2 X TEMA FEMALE	CB-0440-3000
28	MANIFOLD - 2 CYL - 1 X TEMA MALE TO 2 X REGO FEMALE	CB-0440-7000
29	MANIFOLD - 3 CYL - 1 X REGO MALE TO 3 X REGO FEMALE	CB-0440-2000
30	MANIFOLD - 3 CYL - 1 X TEMA MALE TO 3 X TEMA FEMALE	CB-0440-4000
31	MANIFOLD - 3 CYL - REGO - ALTERNATIVE ASSEMBLY	CB-0440-6000
32	MANIFOLD - 3 CYL - 1 X TEMA MALE TO 3 X REGO FEMALE	CB-0440-8000
BARE MANIFOLD HOSE ONLY		
33	0.3M MANIFOLD HOSE (REGO) - ¼NPT / ¼NPT	CB-7603-1100
34	0.3M MANIFOLD HOSE (TEMA) - ¼NPT / 3/8BSP	CB-7603-1400
35	0.5M MANIFOLD HOSE (REGO) - ¼NPT / ¼NPT	CB-7605-1100
36	0.5M MANIFOLD HOSE (TEMA) - ¼NPT / 3/8BSP	CB-7605-1400

Item	Description	Part #
REFUELLING HOSES		
65	REGO - FORECOURT BAYONET	CB-2579-0001
66	REGO - CAR GAS 1 3/4 ACME (GERMANY /IRELAND)	CB-2579-0003
67	REGO - FORECOURT BAYONET + TYPE 2 ADAPTOR GERMANY/ IRELAND ADAPTOR	CB-2579-0004
68	REGO - FORECOURT BAYONET + TYPE 3 ADAPTOR FRENCH / ITALIAN ADAPTOR	CB-2579-0005
69	TEMA - FORECOURT BAYONET	CB-2579-0002
70	TEMA - CAR GAS 1 3/4 ACME (GERMANY /IRELAND)	CB-2579-0006
71	TEMA - FORECOURT BAYONET + TYPE 2 ADAPTOR GERMANY/ IRELAND ADAPTOR	CB-2579-0007
72	TEMA - FORECOURT BAYONET + TYPE 3 ADAPTOR FRENCH / ITALIAN ADAPTOR	CB-2579-0008
<i>ITEMS 65 TO 72 - STANDARD HOSE LENGTH IS 1.8M CUSTOM HOSE LENGTHS ARE AVAILABLE - PLEASE SPECIFY</i>		
73	REGO 7141M (MALE) - REGO 7141M (MALE)	CB-76**-1144
74	REGO 7141F (FEMALE) - REGO 7141F (FEMALE)	CB-76**-1111
75	REGO 7141M (MALE) - REGO 7141F (FEMALE)	CB-76**-1114
76	TEMA 3800 FEMALE - TEMA 3800 FEMALE	CB-76**-1422
77	REGO 7141F - TEMA 3800 FEMALE	CB-76**-1412
78	REGO 7141M - TEMA 3800 FEMALE	CB-76**-1414
<i>THE THIRD AND FOURTH DIGITS OF THE PART NO. REPRESENT THE LENGTH OF THE HOSE IN DECIMETRES. FOR EXAMPLE: A LIQUID HOSE, 3.1M LONG, FOR SHADOW DOUBLE WOULD BE CB-7631-1100</i>		
<i>ITEMS 73 TO 78 - CUSTOM HOSE LENGTHS ARE AVAILABLE - PLEASE SPECIFY</i>		
177	REGO TO CONTINENTAL REFUELLING HOSE	CB-2579-0010
178	TEMA TO CONTINENTAL REFUELLING HOSE	CB-2579-0009
200	UNIVERSAL REFUELLING KIT - REGO (MALE) TO UK POL (MALE) HOSE, 1.8M	CH-6000-1000
CONTAINS THE FOLLOWING ADAPTORS:		
UK POL - LIPTON COUPLING,		
UK POL - REGO FEMALE COUPLING BM144,		
UK POL - US POL,		
UK POL - CARGAS 3/4BSP BAYONET,		
UK POL - CONTINENTAL FITTING		
UK POL - 1 3/4 ACME CARGAS - TYPE 2 (GERMANY/IRELAND)		
UK POL - CARGAS ADAPTOR - TYPE 3 (FRANCE/ITALY)		
300	UNIVERSAL REFUELLING KIT - TEMA TO UK POL (MALE) HOSE, 1.8M	CH-6000-2000
CONTAINS THE FOLLOWING ADAPTORS:		
UK POL - TEMA FEMALE,		
UK POL - LIPTON COUPLING,		
UK POL - US POL,		
UK POL - CARGAS 3/4BSP BAYONET,		
UK POL - CONTINENTAL FITTING		
UK POL - 1 3/4 ACME CARGAS - TYPE 2 (GERMANY/IRELAND)		
UK POL - CARGAS ADAPTOR - TYPE 3 (FRANCE/ITALY)		

ENVELOPE COMPONENTS & ACCESSORIES



CUSTOM HOSE LENGTHS ARE AVAILABLE.

For advice on ordering these contact:

AFTERSALES@CAMERONBALLOONS.CO.UK

Item	Description	Part #
37	REDUCING NIPPLE - ¼ NPT - 3/8 NPT	CB-0440-0007
38	3-WAY T FOR MANIFOLDS - ¼ NPT FEMALE EACH	CB-0440-0005
39	4-WAY T FOR MANIFOLDS - ¼ NPT FEMALE EACH	CB-0440-0006
40	WAVERLEY REDUCER - 3/8BSP MALE - ¼NPT MALE	CB-0440-0017
41	7141M MOD FOR 6LB CYLINDER	CH-7141-0003
42	REGO 7141F DUST CAP	CH-7141-9000
43	REGO FEMALE COUPLING BM144	CH-0144-0001
45	½" FEMALE NPT COUPLING	CH-5000-0003
46	BONNANO PROPANE FILTER	CB-2894-0000
47	UK POL NUT	CH-6000-0005
48	US POL NUT	CH-6000-0007
49	CONTINENTAL REFUELLING FITTING	CH-6000-0008
52	CARGAS REGO 76475C BAYONET ADAPTOR	CH-6000-0012
53	UK POL FEMALE CONNECTOR	CH-6000-0013
54	CARGAS FRENCH ADAPTOR - TYPE 3	CH-6000-0014
55	UK / US POL NIPPLE	CH-6000-0017
58	CARGAS ¾ BSP BAYONET ADAPTOR	CH-6000-0023
59	CARGAS - FORECOURT BAYONET ADAPTOR	CH-6000-0024
60	1¾ ACME CARGAS ADAPTOR - TYPE 2	CH-6000-0025
61	RETROFIT HOSE PROTECTION SLEEVE KIT	CQ-2013-9000
62	HOOK AND LOOP CABLE TIE 325MM	CH-1000-0002
63	NITROGEN KIT (REGO)	CH-0000-0014
64	NITROGEN KIT (TEMA)	CH-0000-0015



ENVELOPE COMPONENTS & ACCESSORIES

IMPORTANT:

A range of different cylinder types exist and it is important to identify the correct type concerned, as the detail fittings are not all interchangeable between types. If in doubt contact:

AFTERSALES@CAMERONBALLOONS.CO.UK

Item	Description	Part #
81	CONTENTS GAUGE GASKET	CB-2561-0000
82	CONTENTS GAUGE BOLTS (DUPLIX STAINLESS STEEL & TITANIUM ONLY)	CY-5000-0013
83	CONTENTS GAUGE BOLT (STAINLESS STEEL & WORTHINGTON ONLY)	CY-5000-0014
84	CONTENTS GAUGE BOLT THUNDER & COLT (M6 X 25 S/S SOCKET CAP)	CY-0006-3025
86	CONTENTS GAUGE - 45 / 60 LTR	CB-2552-0000
87	CONTENTS GAUGE - 56 / 80 LTR	CB-2553-0000
88	CONTENTS GAUGE DIAL & SCREW	CB-2551-0001
89	80% FIX LIQUID LEVEL (FLL) GAUGE - 45 / 60 LTR	CB-2480-0021
90	80% FIX LIQUID LEVEL (FLL) GAUGE - 45 / 60 LTR (WITH NUT)	CB-2480-1021
91	80% FIX LIQUID LEVEL (FLL) GAUGE - 56 / 80 LTR	CB-2480-0022
92	80% FIX LIQUID LEVEL (FLL) GAUGE - 56 / 80 LTR (WITH NUT)	CB-2480-1022
95	FLL GAUGE BLANKING NUT	CB-2483-0000
96	VENT HOSE ASSEMBLY	CB-2482-0000
97	FUELSAFE COUPLING	CB-2482-0001
98	PRESSURE RELIEF DUST PLUG	CT-0250-0004
99	CYLINDER BLANKING PLUG	CT-0250-0013
100	PRESSURE RELIEF VALVE (OMECA)	CB-8412-1000
101	PRESSURE RELIEF VALVE ADAPTOR	CB-8426-0000
102	VAPOUR VALVE - NO PRV - CAMERON	CB-2884-0000
	FOR USE WITH: CB426, CB497, CB599, CB959, CB2088, CB250	
103	VAPOUR VALVE WITH PRV - CAMERON	DISCONTINUED
	FOR USE WITH: CB426, CB497, CB599, CB959, CB2088, CB250	
104	VAPOUR VALVE WITH PRV - THUNDER & COLT / SKY	CB-2883-0000
	FOR USE WITH: V20, V30 & V40	
107	VAPOUR VALVE WITH DIP TUBE (CAMERON TITANIUM CYLINDERS)	CQ-2001-0000
	FOR USE WITH: CB2380S, CB2383S, CB2385S & CB2387S	
108	VAPOUR REGULATOR -SYSTEM - DYNAQUIP	CQ-2000-1000
109	VAPOUR REGULATOR SYSTEM - TEMA	CQ-2000-2000

 81 CB-2561-0000	 82 CY-5000-0013	 83 CY-5000-0014	 84 CY-0006-3025 <i>T&C ONLY</i>	 86 CB-2552-0000
 87 CB-2553-0000	 88 CB-2551-0001	 89 CB-2480-0021	 90 CB-2480-1021 <i>INC. BLANKING NUT</i>	 91 CB-2480-0022
 92 CB-2480-1022 <i>INC. BLANKING NUT</i>	 95 CB-2483-0000	 96 CB-2482-0000	 97 CB-2482-0001	 98 CT-0250-0004
 99 CT-0250-0013	 100 CB-8412-1000	 101 CB-8426-0000	 102 CB-2884-0000	 103 DISCONTINUED
 104 CB-2883-0000	 107 CQ-2001-0000	 108 CQ-2000-1000 <i>DYNAQUIP</i>	 109 CQ-2000-2000 <i>TEMA</i>	

IMPORTANT:

A range of different cylinder types exist and it is important to identify the correct type concerned, as the detail fittings are not all interchangeable between types. If in doubt contact:

AFTERSALES@CAMERONBALLOONS.CO.UK

Item	Description	Part #
110	SCHROEDER VAPOUR FITTING	CB-2567-0000
111	DYNAQUIP Q.RELEASE SOCKET FOR CALOR FITTING	CT-0341-0001
112	VAPOUR VALVE REPAIR KIT	CT-0901-0002
113	BM VAPOUR - CONE / 'O' RING / SEAL	CB-0614-3022
114	BM VAPOUR - SEALING RING	CB-0614-3160
115	BM VAPOUR - SCREW 244A5050	CB-0614-5050
117	REGO 8180 - LIQUID VALVE COVER	CT-8180-9000
118	REGO 8180 - REPLACEMENT STRAPS	CT-8180-9001
119	REGO 8180 - LIQUID VALVE SPRING	CT-8100-0013
120	REGO 8180 - LIQUID VALVE 'O' RING SET	CB-2621-0000
121	REGO 8180 - LIQUID VALVE MAIN SEAL 'O' RING	CB-2624-0000
122	DESEATING TOOL	CT-8180-8000
123	BM LIQUID VALVE	CB-0824-0001
124	BM LIQUID VALVE SELF SEAL SERVICE KIT	CB-2628-0000
125	BM LIQUID VALVE MAIN SEAL KIT	CB-2629-0000
126	TEMA 3800 SERIES MALE COUPLING	CB-0671-0007
127	TEMA DUST CAP	CH-3800-0006
128	TEMA 1300A PILOT QUICK RELEASE 3/8BSPM	CT-1300-0003
129	TEMA 1300EC FEMALE 1/4BSPTM	CT-1300-0007
130	TEMA 3800 FEMALE	CH-3800-0001
131	TEMA 3815 DUST PLUG	CH-3800-0004
133	3/8BSP DOWTY SEAL	CH-3800-0003
165	WARNING LABELS - CYLINDER	CT-2000-0003
176	6MM POLYESTER CORD FOR CYLINDER COVERS	CE-4106-0006
177	REGO 7141M COUPLING FOR MANIFOLDS	CH-7141-0002

 110 CB-2567-0000	 111 CT-0341-0001	 112 CT-0901-0002	 113 CB-0614-3022 NO LONGER AVAILABLE / CONTACT CBL	 114 CB-0614-3160 NO LONGER AVAILABLE / CONTACT CBL
 115 CB-0614-5050 NO LONGER AVAILABLE / CONTACT CBL	 117 CT-8180-9000	 118 CT-8180-9001	 119 CT-8180-9001	 120 CB-2621-0000
 121 CB-2624-0000	 122 CT-8180-8000	 123 CB-0824-0001	 124 CB-2628-0000	 125 CB-2629-0000
 126 CB-0671-0007	 127 CH-3800-0006	 128 CT-1300-0003	 129 CT-1300-0007	 130 CH-3800-0001
 131 CH-3800-0004	 133 CH-3800-0003	 165 CT-2000-0003 WARNING FOR USE IN HOT AIR BALLOONS ONLY	 176 CE-4106-0006	 177 CH-7141-0002

FOR INFORMATION REGARDING QUICK SHUT-OFF VALVES ON ALL T&C V20 / V30 / V40 & T&C WORTHINGTONS, PLEASE CONTACT: AFTERSALES@CAMERONBALLOONS.CO.UK

Item	Description	Part #
134	DOWTY SEAL TEMA SOCKET/ADAPTOR	CT-1300-0002
135	DOWTY SEAL TEMA ADAPTOR/REGULATOR	CT-1300-0004
136	TEMA 'O' RING PACK	CB-2631-0000
137	REGO QUICK SHUT OFF PARTS - SEE TABLE BELOW	CB-0671-*000
<i>PACKET CONSISTS OF ITEMS: 139, 140, 141, 142, 144 (X 4 UNITS) & 149</i> <i>PLEASE SPECIFY CYLINDER DRAWING NUMBER FOR HANDLE SELECTION - 145 OR 176</i>		
138	TEMA QUICK SHUT OFF PARTS - SEE TABLE BELOW	CB-0671-*000
<i>PACKET CONSISTS OF ITEMS: 126, 131, 133, 139, 143, 144 (X 4 UNITS) & 148</i> <i>PLEASE SPECIFY CYLINDER DRAWING NUMBER FOR HANDLE SELECTION - 145 OR 176</i>		
139	FLANGE ADAPTOR (THREADED)	CB-0437-0000
140	WORCESTER BALL VALVE	CB-0392-0017
141	REGO 7/14IM 7/8 UNEF THREAD - HIFLOW (NOW FITTED TO ALL CYLINDERS)	CB-7901-0000
142	REGO ADAPTOR BLOCK QUICK SHUT OFF	CB-8409-0000
143	TEMA ADAPTOR BLOCK QUICK SHUT OFF	CB-8410-0000
144	M6 X 65 HEX HEAD BOLT	CY-0006-0065
145	QSO HANDLE (INC. RED SLEEVE)	CB-8416-0000
<i>FOR CB250, CB426, CB497, CB599, CB959, CB2088, CB2380, CB2383, CB2385 & CB2387</i>		
146	QUICK SHUT OFF HANDLE SLEEVE (RED)	CB-8416-0002
147	WORCESTER VALVE SEAL KIT	CB-0392-0018
148	WORCESTER/TEMA THREADED ADAPTOR	CB-0671-0006
149	5/8 UNEF DOWTY SEAL	CB-0671-0004
152	CYLINDER FOAM - 40 / 45 LTR - STAINLESS STEEL / ALUMINIUM	CG-1100-0005
153	CYLINDER FOAM - 60 LTR - STAINLESS STEEL	CG-1100-0006
154	CYLINDER FOAM - 60 LTR - STAINLESS STEEL TALL	CG-1100-0008
155	CYLINDER FOAM - 80 LTR - STAINLESS STEEL	CG-1100-0007
163	STAINLESS STEEL COVER (INCLUDING FOAM)	CT-8000-2000
164	STAINLESS STEEL COVER ONLY	CT-8000-3000
165	QSO HANDLE (INC. RED SLEEVE) - FOR CB2900, CB2901, CB2902 & CB2903	CB-8416-2000
166	CYLINDER RING COVER - CAMERON	CB-2198-0001
167	CYLINDER RING COVER - THUNDER & COLT	CB-2198-0002

Part # Quick Shut Off Assembly

CB-0671-1000	TEMA - CB250, CB426, CB497, CB599, CB959, CB2088, CB2380, CB2383, CB2385 & CB2387
CB-0671-2000	REGO - CB250, CB426, CB497, CB599, CB959, CB2088, CB2380, CB2383, CB2385 & CB2387
CB-0671-3000	TEMA - CB2900, CB2901, CB2902 & CB2903
CB-0671-4000	REGO - CB2900, CB2901, CB2902 & CB2903
CB-0671-5000	TEMA - CB2990
CB-0671-6000	REGO - CB2990

 <p>134 CT-1300-0002</p>	 <p>135 CT-1300-0004</p>	 <p>136 CB-2631-0000</p>	 <p>137 CB-0671-2000 <i>SEE 'MISCELLANEOUS' FOR COMPONENT PARTS</i></p>	 <p>138 CB-0671-1000 <i>SEE 'MISCELLANEOUS' FOR COMPONENT PARTS</i></p>
 <p>139 CB-0437-0000</p>	 <p>140 CB-0392-0017</p>	 <p>141 CB-7901-0000 <i>HIFLOW</i></p>	 <p>142 CB-8409-0000 <i>REGO</i></p>	 <p>143 CB-8410-0000 <i>TEMA</i></p>
 <p>144 CY-0006-0065</p>	 <p>145 CB-8416-0000</p>	 <p>146 CB-8416-0002</p>	 <p>147 CB-0392-0018</p>	 <p>148 CB-0671-0006</p>
 <p>149 CB-0671-0004</p>	 <p>152 CG-1100-0005 <i>CYL FOAM</i></p>	 <p>153 CG-1100-0006 <i>CYL FOAM</i></p>	 <p>154 CG-1100-0008 <i>CYL FOAM</i></p>	 <p>155 CG-1100-0007 <i>CYL FOAM</i></p>
 <p>163 CT-8000-2000 <i>INC. FOAM</i> <i>SPECIFY MANUFACTURER, DRW NO. & COLOUR</i></p>	 <p>164 CT-8000-3000 <i>COVER ONLY</i> <i>SPECIFY MANUFACTURER, DRW NO. & COLOUR</i></p>	 <p>166 CB-2198-0001</p>	 <p>167 CB-2198-0002 <i>T&C</i></p>	 <p>165 CB-8416-2000</p>

FOR INFORMATION REGARDING ALUMINIUM FUEL CYLINDERS, PLEASE CONTACT: AFTERSALES@CAMERONBALLOONS.CO.UK

IMPORTANT:

A range of different cylinder types exist and it is important to identify the correct type concerned, as the detail fittings are not all interchangeable between types. If in doubt contact:

AFTERSALES@CAMERONBALLOONS.CO.UK

Item	Description	Part #
ALUGAS 50L ALUMINIUM		
86	CONTENTS GAUGE	CB-2552-0000
89	80% FIX LIQUID LEVEL (FLL) GAUGE	CB-2480-0021
90	80% FIX LIQUID LEVEL (FLL) GAUGE (WITH BLANKING NUT)	CB-2480-1021
95	FLL GAUGE BLANKING PLUG	CB-2483-0000
98	PRESSURE RELIEF DUST PLUG	CT-0250-0004
100	PRESSURE RELIEF VALVE (OMEGA)	CB-8412-1000
117	REGO 8180 - LIQUID VALVE COVER	CT-8180-9000
156	CYLINDER FOAM	CB-2990-2000
161	CYLINDER COVER (EXCLUDES FOAM)	CB-2990-3000
168	CYLINDER RING COVER	CB-2990-4000
169	LIQUID VALVE (WITH INTEGRAL DIP TUBE)	CB-2992-0000
175	4MM POLYESTER CORD FOR ALUGAS COVERS	CB-2990-2006
177	REGO QUICK SHUT OFF PARTS	CB-0671-8000
178	TEMA QUICK SHUT OFF PARTS	CB-0671-7000
179	ALUGAS GAUGE ASSEMBLY	CB-7913-0000
180	ALUGAS DIAL	CB-7913-0001
183	FLANGED ADAPTOR, QSO VALVE	CB-2945-0000

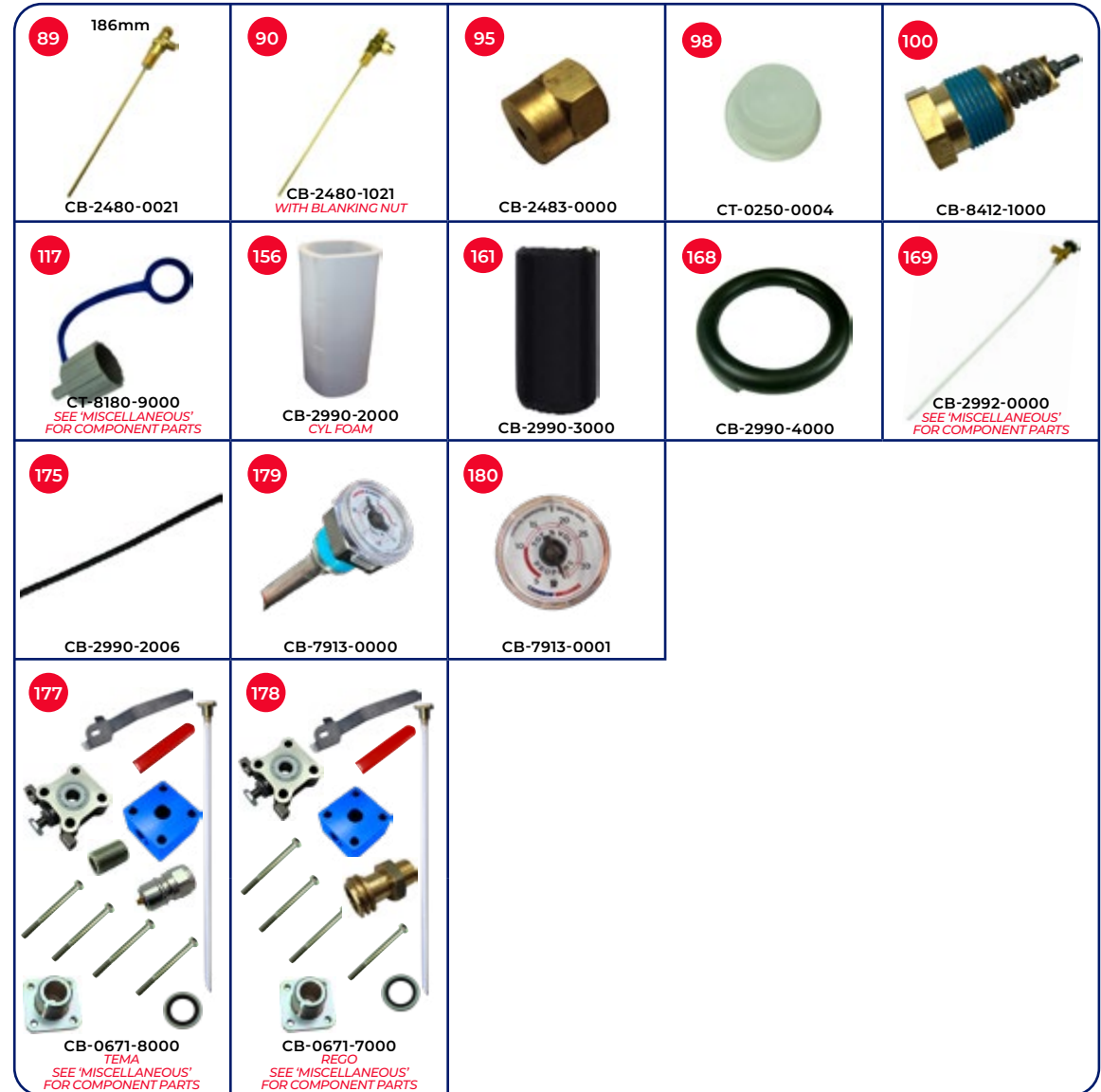























FOR INFORMATION REGARDING QUICK SHUT-OFF VALVES ON WORTHINGTONS, PLEASE CONTACT: AFTERSALES@CAMERONBALLOONS.CO.UK

IMPORTANT:

A range of different cylinder types exist and it is important to identify the correct type concerned, as the detail fittings are not all interchangeable between types. If in doubt contact:

AFTERSALES@CAMERONBALLOONS.CO.UK

Item	Description	Part #
WORTHINGTON		
81	CONTENTS GAUGE GASKET	CB-2561-0000
83	CONTENTS GAUGE BOLT	CY-5000-0014
85	CONTENTS GAUGE	CB-2551-0000
89	80% FIX LIQUID LEVEL (FLL) GAUGE	CB-2480-0021
90	80% FIX LIQUID LEVEL (FLL) GAUGE (WITH BLANKING NUT)	CB-2480-1021
95	FLL GAUGE BLANKING PLUG	CB-2483-0000
96	VENT HOSE ASSEMBLY	CB-2482-0000
98	PRESSURE RELIEF DUST PLUG	CT-0250-0004
99	CYLINDER BLANKING PLUG	CT-0250-0013
100	PRESSURE RELIEF VALVE (OMEGA)	CB-8412-1000
107	VAPOUR VALVE WITH DIP TUBE (MASTER CYLINDERS)	CQ-2001-0000
108	VAPOUR REGULATOR SYSTEM - DYNAQUIP	CQ-2000-1000
109	VAPOUR REGULATOR SYSTEM - TEMA	CQ-2000-2000
117	REGO 8180 - LIQUID VALVE COVER	CT-8180-9000
123	LIQUID VALVE	CB-0824-0001
<i>CYLINDER DESIGN VARIATION MAY NOT ALLOW INSTALL</i>		
127	TEMA DUST CAP	CH-3800-0006
137	REGO QUICK SHUT OFF PARTS	CB-0671-2000
<i>PACKET CONSISTS OF ITEMS: 139, 140, 141, 142, 144 (X 4 UNITS), 145 & 149</i>		
138	TEMA QUICK SHUT OFF PARTS	CB-0671-1000
<i>PACKET CONSISTS OF ITEMS: 126, 131, 133, 139, 143, 144 (X 4 UNITS), 145 & 148</i>		
152	CYLINDER FOAM	CG-1100-0005
168	CYLINDER COVER (PLEASE SPECIFY COLOUR)	CT-8000-1000
169	CYLINDER FOAM & COVER (PLEASE SPECIFY COVER COLOUR)	CT-8000-2000
176	6MM POLYESTER CORD FOR CYLINDER COVERS	CE-4106-0006

 <p>81 CB-2561-0000</p>	 <p>83 CY-5000-0014</p>	 <p>85 CB-2551-0000</p>	 <p>89 186mm CB-2480-0021</p>	 <p>90 CB-2480-1021 WITH BLANKING NUT</p>
 <p>95 CB-2483-0000</p>	 <p>96 CB-2482-0000 SEE 'MISCELLANEOUS' FOR COMPONENT PARTS</p>	 <p>98 CT-0250-0004</p>	 <p>99 CT-0250-0013</p>	 <p>100 CB-8412-1000</p>
 <p>107 CQ-2001-0000</p>	 <p>108 CQ-2000-1000 DYNAQUIP</p>	 <p>109 CQ-2000-2000 TEMA</p>	 <p>117 CT-8180-9000</p>	 <p>123 CB-0824-0001 SEE NOTES SEE 'MISCELLANEOUS' FOR COMPONENT PARTS</p>
 <p>137 CB-0671-2000 REGO SEE 'MISCELLANEOUS' FOR COMPONENT PARTS</p>	 <p>138 CB-0671-1000 TEMA SEE 'MISCELLANEOUS' FOR COMPONENT PARTS</p>	 <p>152 CG-1100-0005</p>	 <p>127 CH-3800-0006</p>	 <p>168 CT-8000-1000 SPECIFY COVER COLO</p>
 <p>169 CT-8000-2000 INC. FOAM SPECIFY COVER COLOUR</p>	 <p>176 CE-4106-0006</p>			













FOR INFORMATION REGARDING DUPLEX FUEL CYLINDERS, PLEASE CONTACT: AFTERSALES@CAMERONBALLOONS.CO.UK

IMPORTANT:

A range of different cylinder types exist and it is important to identify the correct type concerned, as the detail fittings are not all interchangeable between types. If in doubt contact:

AFTERSALES@CAMERONBALLOONS.CO.UK

Item	Description	Part #
COMMON COMPONENTS TO DUPLEX STAINLESS STEEL CYLINDERS		
81	CONTENTS GAUGE GASKET	CB-2561-0000
82	CONTENTS GAUGE BOLT	CY-5000-0013
96	VENT HOSE ASSEMBLY	CB-2482-0000
98	PRESSURE RELIEF DUST PLUG	CT-0250-0004
99	CYLINDER BLANKING PLUG	CT-0250-0013
100	PRESSURE RELIEF VALVE (OMECA)	CB-8412-1000
107	VAPOUR VALVE WITH DIP TUBE (MASTER CYLINDERS)	CQ-2001-0000
108	VAPOUR REGULATOR - DYNAQUIP	CQ-2000-1000
109	VAPOUR REGULATOR - TEMA	CQ-2000-2000
117	REGO 8180 - LIQUID VALVE COVER	CT-8180-9000
123	LIQUID VALVE	CB-0824-0001
127	TEMA DUST CAP	CH-3800-0006
137	REGO QUICK SHUT OFF PARTS	CB-0671-4000
<i>PACKET CONSISTS OF ITEMS: 139, 140, 141, 142, 144 (X 4 UNITS), 176 & 149</i>		
138	TEMA QUICK SHUT OFF PARTS	CB-0671-3000
<i>PACKET CONSISTS OF ITEMS: 126, 131, 133, 139, 143, 144 (X 4 UNITS), 176 & 148</i>		
166	CYLINDER RING COVER - CAMERON	CB-2198-0001

 <p>81 CB-2561-0000</p>	 <p>82 CY-5000-0013</p>	 <p>96 CB-2482-0000 <i>SEE 'MISCELLANEOUS' FOR COMPONENT PARTS</i></p>	 <p>98 CT-0250-0004</p>	 <p>99 CT-0250-0013</p>
 <p>100 CB-8412-1000</p>	 <p>107 CQ-2001-0000</p>	 <p>108 CQ-2000-1000 <i>DYNAQUIP</i></p>	 <p>109 CQ-2000-2000 <i>TEMA</i></p>	 <p>117 CT-8180-9000 <i>SEE 'MISCELLANEOUS' FOR COMPONENT PARTS</i></p>
 <p>123 CB-0824-0001 <i>SEE 'MISCELLANEOUS' FOR COMPONENT PARTS</i></p>	 <p>127 CH-3800-0006</p>	 <p>166 CB-2198-0001</p>		
 <p>137 CB-0671-4000 <i>REGO</i> <i>SEE 'MISCELLANEOUS' FOR COMPONENT PARTS</i></p>		 <p>138 CB-0671-3000 <i>TEMA</i> <i>SEE 'MISCELLANEOUS' FOR COMPONENT PARTS</i></p>		

FOR INFORMATION REGARDING DUPLEX FUEL CYLINDERS, PLEASE CONTACT: AFTERSALES@CAMERONBALLOONS.CO.UK

IMPORTANT:

A range of different cylinder types exist and it is important to identify the correct type concerned, as the detail fittings are not all interchangeable between types. If in doubt contact:

AFTERSALES@CAMERONBALLOONS.CO.UK





Item	Description	Part #
45L DUPLEX STAINLESS STEEL CYLINDER - CB2900		
86	CONTENTS GAUGE	CB-2552-0000
89	80% FIXED LIQUID LEVEL (FLL) GAUGE	CB-2480-0021
90	80% FIXED LIQUID LEVEL (FLL) GAUGE (WITH BLANKING NUT)	CB-2480-1021
157	CYLINDER FOAM	CG-1100-0001
170	CYLINDER COVER (PLEASE SPECIFY COLOUR)	CT-8000-3045
60L DUPLEX STAINLESS STEEL CYLINDER - CB2901		
86	CONTENTS GAUGE	CB-2552-0000
89	80% FIXED LIQUID LEVEL (FLL) GAUGE	CB-2480-0021
90	80% FIXED LIQUID LEVEL (FLL) GAUGE (WITH BLANKING NUT)	CB-2480-1021
158	CYLINDER FOAM	CG-1100-0002
171	CYLINDER COVER (PLEASE SPECIFY COLOUR)	CT-8000-3060
72L DUPLEX STAINLESS STEEL CYLINDER - CB2903		
87	CONTENTS GAUGE	CB-2553-0000
91	80% FIXED LIQUID LEVEL (FLL) GAUGE	CB-2480-0022
92	80% FIXED LIQUID LEVEL (FLL) GAUGE (WITH BLANKING NUT)	CB-2480-1022
159	CYLINDER FOAM	CG-1100-0004
172	CYLINDER COVER (PLEASE SPECIFY COLOUR)	CT-8000-3072
176	6MM POLYESTER CORD FOR ALL COVERS	CE-4106-0006



Item	Description	Part #
2.5HP		
1	2.5HP IMPELLER	CB-8980-0003
2	2.5HP FAN FINGER GUARD (H= 514MM, L= 461MM & W= 320MM)	CB-8980-0004
5.5HP		
3	5.5HP COMPLETE FAN GUARD (CURRENT STYLE - FRONT & BACK) (H= 880MM, L= 706MM & W= 485MM)	CB-6446-6447
4	5.5HP FAN GUARD (CURRENT STYLE - FRONT ONLY)	CB-6446-0000
5	5.5HP COMPLETE FAN GUARD (OLD STYLE RED. REPLACEMENT = BLACK)	CF-5000-0006
6	5.5HP FAN HUB	CB-0698-0002
7	5.5HP CARBON FIBRE PROPELLER	CB-6422-0000
8	5.5HP CARBON FIBRE PROPELLER REPLACEMENT KIT	CB-6422-1000
9	5.5HP AIR FILTER	CF-5000-0003
10	5.5HP FAN COOLING IMPELLOR	CF-5000-0004
8HP		
11	8HP COMPLETE FAN GUARD (FRONT & BACK) (H= 965MM, L= 850MM & W= 555MM)	CB-6449-6450
12	8HP FAN GUARD (FRONT ONLY)	CB-6449-0000
13	8HP FAN GUARD (OLD STYLE WITH WIRE CUT OUT)	CF-1300-0006
14	8HP FAN GUARD (OLD STYLE WITHOUT WIRE CUT OUT)	CF-8000-0006
15	8HP FAN HUB	CB-0699-0002
16	8HP FAN COOLING IMPELLOR	CF-8000-0004
17	8HP AIR FILTER	CF-8000-0003
18	8HP CARBON FIBRE PROPELLER	CB-6423-0000
19	8HP CARBON FIBRE PROPELLER REPLACEMENT KIT	CB-6423-1000
<i>IF REPLACING A WOODEN PROPELLER WITH A CARBON FIBRE ONE THE APPROPRIATE REPLACEMENT BOLT KIT IS REQUIRED</i>		
13HP		
13	13HP FAN GUARD (OLD STYLE WITH WIRE CUT OUT)	CF-1300-0006
20	13HP FAN HUB	CB-0699-0003
21	13HP FAN COOLING IMPELLOR	CF-1300-0004
22	13HP AIR FILTER	CF-1300-0003
23	13HP CARBON FIBRE PROPELLER	CB-6436-0000
19	13HP CARBON FIBRE PROP REPLACEMENT KIT	CB-6423-1000
<i>IF REPLACING A WOODEN PROPELLER WITH A CARBON FIBRE ONE THE APPROPRIATE REPLACEMENT BOLT KIT IS REQUIRED</i>		
13HP XL		
24	13HP XL CARBON FIBRE PROPELLER	CB-6424-0000
25	13HP XL FAN GUARD (NO LONGER AVAILABLE)	CB-6144-0000
26	13HP XL FRONT GUARD	CB-6451-0000
27	13HP COMPLETE FAN GUARD (FRONT & BACK) (H= 952MM, L= 153MM & W= 952MM)	CB-6451-6452

Item	Description	Part #
MISCELLANEOUS		
28	FAN GUARD SCREW	CF-5813-0000
29	RUBBER MOUNTS FOR FANS	CF-5000-0007
30	FAN ENGINE MOUNTING BUFFER	CB-6444-0000
31	FAN GUARD BUFFER	CB-6484-0000
32	M6 X 10 SS SET SCREW	CY-0006-0010
33	M6 X 45 BOLT	CY-0006-0045
34	M6 PLAIN WASHER	CY-0006-2008
35	M8 SPRING WASHER	CY-1008-2007
36	M10 SPRING WASHER	CY-1010-2007
37	M6 X 20	CY-0006-0020
38	M6 NYLOC NUTS	CY-0006-1002
39	M8 X 40 HEX HEAD BOLT	CY-1008-0040
40	M8 NYLOC BZP	CY-1008-1002
41	M10 NYLOC BZP	CY-1010-1002
42	M10 PLAIN WASHER	CY-0010-2030
43	M6 X 50 BZP WASHER (WHEEL - MUD) 5.5HP, 8HP & 13HP	CY-1006-2009
44	M6 X 25 BZP WASHER (WHEEL - MUD) 2.5HP	CY-1006-2006
45	FAN WHEEL	CB-6453-0000

*** ALL NEW REPLACEMENT GUARDS WILL BE SUPPLIED IN BLACK, PLASTIC DIP COATING ***

TYPE	OLD STYLE RED CAGE COMPLETE - WITHOUT S/S FRAME RING FOR ATTACHING GUARD	CURRENT BLACK CAGE COMPLETE - WITH S/S FRAME RING FOR ATTACHING GUARD	PROP LENGTH	PCD 4-STUD
	Dimensions			
5.5HP	679mm Dia. 150mm Depth	700mm Dia. 140mm Depth	610mm	
8HP	834mm Dia. 150mm Depth	847mm Dia. 140mm Depth	750mm	
13HP	834mm Dia. 150mm Depth WITH EXHAUST CUT OUT IN REAR GUARD	N/A	750mm	
13HP XL	N/A	952mm Dia. 150mm Depth	840mm	

* TWO VERSIONS WERE MANUFACTURED - WITH AND WITHOUT EXHAUST CUT-OUT IN REAR GUARD

 <p>1 CB-8980-0003</p>	 <p>2 CB-8980-0004 2.5 HP GUARD</p>	 <p>3 CB-6447-6446 5.5 HP SET</p>	 <p>4 CB-6446-0000 5.5 HP GUARD</p>	 <p>5 CF-5000-0006 5.5 HP SET OLD STYLE</p>	 <p>6 CB-0698-0002</p>	 <p>7 CB-6422-0000</p>	 <p>8 CB-6422-1000</p>	 <p>9 CF-5000-0003</p>
 <p>10 CF-5000-0004</p>	 <p>11 CB-6449-6450 8 HP SET</p>	 <p>12 CB-6449-0000 8 HP GUARD</p>	 <p>13 CF-1300-0006 8 + 13 HP SET</p>	 <p>14 CF-8000-0006 8 HP SET</p>	 <p>15 CB-0699-0002</p>	 <p>16 CF-8000-0004</p>	 <p>17 CF-8000-0003</p>	 <p>18 CB-6423-0000</p>
 <p>19 CB-6423-1000</p>	 <p>20 CB-0699-0003</p>	 <p>21 CF-1300-0004</p>	 <p>22 CF-1300-0003</p>	 <p>23 CB-6436-0000</p>	 <p>24 CB-6424-0000</p>	 <p>25 CB-6144-0000 13 HP SET NO LONGER AVAILABLE</p>	 <p>26 CB-6451-0000 13 HP XL GUARD</p>	 <p>27 CB-6451-6452 13 HP XL SET</p>
 <p>28 CF-5813-0000</p>	 <p>29 CF-5000-0007</p>	 <p>30 CB-6444-0000</p>	 <p>31 CB-6484-0000</p>	 <p>32 CY-0006-0010</p>	 <p>33 CY-0006-0045</p>	 <p>34 CY-0006-2008</p>	 <p>35 CY-1008-2007</p>	 <p>36 CY-1010-2007</p>
 <p>37 CY-0006-0020</p>	 <p>38 CY-0006-1002</p>	 <p>39 CY-1008-0040</p>	 <p>40 CY-1008-1002</p>	 <p>41 CY-1010-1002</p>	 <p>42 CY-0010-2030</p>	 <p>43 CY-1006-2009</p>	 <p>44 CY-1006-2006</p>	 <p>45 CB-6453-0000</p>



cameronballoons.co.uk



sales@cameronballoons.co.uk



+44(0)117 9637216

St.Johns Street, Bedminster, Bristol, BS3 4NH UK